

MATERIAL&DESIGNLIGHTINGMATE  
RIAL&DESIGNLIGHTINGMATERIAL&  
DESIGNLIGHTINGMATERIAL&DESI  
GNLIGHTINGMATERIAL&DESIGNLI  
GHTINGMATERIAL&DESIGNLIGHTING  
MATERIAL&DESIGNLIGHTINGMATE  
RIAL&DESIGNLIGHTINGMATERIAL&DE  
SIGNLIGHTING**MATERIAL&DESIGN**  
LIGHTINGMATERIAL&DESIGNLIGHTINGMA  
TERIAL&DESIGNLIGHTINGMATERIAL&  
DESIGNLIGHTINGMATERIAL&DESIGNLI  
GHTINGMATERIAL&DESIGNLIGHTINGMA  
TERIAL&DESIGNLIGHTINGMATERIAL&  
DESIGNLIGHTINGMATERIAL&DESIGNLI  
GHTINGMATERIAL&DESIGN**LIGHTING**

**MA[&]DE**

**MA[&]DE**



Material & Design **2018**

**linealight**group



IT — Un'azienda ha una filosofia di progetto definita dalla sua storia e dalle sfide che l'attendono, dalla strada percorsa e ancora da percorrere. Linea Light Group da trent'anni concepisce la luce come un materiale con cui costruire ambienti e definire spazi. MA[&]DE è la collezione che più di ogni altra unisce design e tecnologia, una filosofia di progetto che nasce dalla volontà di definire un ideale di bellezza funzionale.

FR — La philosophie conceptuelle de l'entreprise est définie par son histoire, par les défis qui l'attendent, par le chemin parcouru et qui reste à parcourir. Depuis trente ans, Linea Light Group conçoit la lumière comme une matière avec laquelle créer des ambiances et définir des espaces. MA[&]DE est la collection qui, plus que toute autre, unit design et technologie, une philosophie conceptuelle qui naît de la volonté de définir un idéal de beauté fonctionnelle.

DE — Ein Unternehmen hat eine Projektphilosophie, die von seiner Geschichte und den Herausforderungen geprägt ist, denen sich das Unternehmen stellt, und vom Weg, den es gegangen ist und den es gehen wird. Seit dreißig Jahren nimmt die Linea Light Group das Licht als ein Material wahr, mit dem Umgebungen erschaffen und Räume definiert werden können. MA[&]DE ist die Kollektion, die mehr als alle anderen Design und Technologie verbindet, eine Projektphilosophie, die aus dem Willen heraus entstanden ist, ein funktionelles Schönheitsideal zu definieren.

ES — Una empresa tiene una filosofía de proyecto, definida por su historia y por los retos futuros, por el camino recorrido y por recorrer. Desde hace treinta años Linea Light Group concibe la luz como un material con el que construir ambientes y definir espacios. MA[&]DE es la colección que logra conjugar, mejor que ninguna, diseño y tecnología, una filosofía de proyecto, fruto de la voluntad de definir un ideal de belleza funcional.

PY — Концепция проекта определяется историей компании и теми целями, к которым она стремится, тем путем, который уже был пройден и тем, который еще предстоит пройти. Уже тридцать лет подряд Linea Light Group относится к свету как к материалу, который создает помещения и определяет пространства. MA[&]DE – это коллекция, в которой как ни в какой другой дизайн сочетается с технологией. В основе этого проекта лежит желание создать идеал функциональной красоты.

EN — A company has a design philosophy defined by its history and challenges ahead, the road traveled and still to go. Linea Light Group for over thirty years conceived light as a material wherewith build environments and define spaces. MA[&]DE is the collection that, more than any other, unites design and technology, a project philosophy built with designers' collaboration, defining a functional beauty ideal.

<sup>IT</sup> — L'identità MA[&]DE risiede nell'innovativo concetto di design che caratterizza tutte le creazioni della collezione. Un design tecnologico, mai fine a sé stesso. Alla cura per i minimi dettagli si accompagna la ricerca dello snodo perfetto, per un movimento sempre fluido delle parti mobili. All'adozione di linee eleganti e minimali si unisce l'impiego di tecnologie non invasive.

<sup>FR</sup> — L'identité MA[&]DE consiste dans le concept innovateur de design qui caractérise toutes les créations de la collection. Un design technologique qui n'est jamais une fin en soi mais. Le soin apporté aux moindres détails est uni à la recherche de l'articulation parfaite, pour un mouvement toujours fluide des parties mobiles. L'adoption de lignes élégantes et épurées est associée à l'emploi de technologies non invasives.

<sup>DE</sup> — Die Identität von MA[&]DE liegt in dem innovativen Design-Konzept, das alle Leuchten der Kollektion auszeichnet. Ein technologisches und gleichzeitig zweckmäßiges Design, das den Leuchten einen echten Mehrwert verleiht. Die sorgfältige Ausführung jedes noch so kleinen Details ist mit der Suche nach dem perfekten Gelenk verbunden, das für eine fließende Bewegung der beweglichen Teile garantiert. Das elegante, minimalistische Design ist mit nicht invasiven Technologien verbunden.

<sup>ES</sup> — La identidad MA[&]DE reside en el concepto innovador de diseño, que caracteriza todas las creaciones de la colección. Un diseño tecnológico, que va más allá de sí mismo. El cuidado de los mínimos detalles se conjuga con la búsqueda de una articulación perfecta para lograr un movimiento siempre fluido de las partes móviles. La adopción de líneas elegantes y minimalista se une al empleo de tecnologías no invasivas.

<sup>PY</sup> — Самобытность MA[&]DE заключается в новаторской концепции дизайна, который характеризует все творения коллекции. Технологический дизайн, который никогда не является самоцелью. С продуманностью мельчайших деталей сочетается поиск идеального шарнира для обеспечения плавного движения подвижных элементов. Элегантные минималистские линии соседствуют с использованием неинвазивных технологий

<sup>EN</sup> — The MA[&]DE identity lies in an innovative design's concept characterizing all collection's creation. A technologic design, not for its own sake. Meticulous attention to the smallest details is associated to the research for the perfect joint for a movable parts smoother movement. Attention to the aesthetic, elegant and minimal lines with non-invasive technologies.



IT — Lavoriamo per garantire la massima efficienza in termini prestazionali, impiegando diodi Led di prima qualità e sempre di ultima generazione, tutti CRI90 per una fedeltà di riproduzione dei colori assoluta. Il confronto con le principali figure di riferimento del mondo della luce è continuo, per anticipare nuovi trend sia estetici che materici. MA[&]DE è Material & Design. MA[&]DE è arredare con la luce.

FR — Nous travaillons pour garantir des performances d'une efficacité maximale, en utilisant des diodes Led de première qualité et toujours de dernière génération, toutes IRC90 pour une reproduction fidèle et absolue des couleurs. La confrontation avec les principales figures de référence du monde de la lumière est continue, afin d'anticiper les nouvelles tendances esthétiques et matérielles. MA[&]DE : Matière & Design. MA[&]DE : décorer avec la lumière.

DE — Wir arbeiten, um für maximale Effizienz im Hinblick auf die Leistung zu garantieren, und verwenden nur LED Leuchtdioden höchster Qualität und der jüngsten Generation, alle mit CRI90 für eine absolut originalgetreue Farbwiedergabe. Wir setzen uns täglich mit den wichtigsten Playern in der Welt des Lichts auseinander, um neuen ästhetischen und materischen Trends vorzugreifen. MA[&]DE steht für Material & Design. MA[&]DE steht für Einrichten mit Licht.

ES — Trabajamos para asegurar la máxima eficiencia, hablando en términos de prestaciones, para ello empleamos diodos Led de primera calidad y siempre de última generación, todos ellos CRI90 para asegurar una fidelidad absoluta de reproducción de los colores. La confrontación con las principales figuras de referencia del mundo de la luz es permanente, para adelantarnos a las tendencias estéticas y matéricas. MA[&]DE es Material & Diseño. MA[&]DE es decorar con la luz.

PY — Мы работаем над тем, чтобы обеспечить максимальную эффективность эксплуатационных характеристик с использованием высококачественных светодиодов последнего поколения, все из которых имеют CRI90, гарантирующий точное воспроизведение цветов. Диалог с главными фигурами мира освещения является постоянным, что позволяет предвосхищать новые тенденции как в плане внешнего вида, так и материалов. MA[&]DE – это материалы и дизайн. MA[&]DE – это создание интерьера при помощи света.

EN — We work to ensure maximum efficiency in terms of performance, using top-quality and always last generation diodes, all CRI90 for the better color reproduction. We have a constant dialogue with the main lighting professionals to anticipate materials and esthetical trends. MA[&]DE means Material & Design. MA[&]DE is furnishing with light.

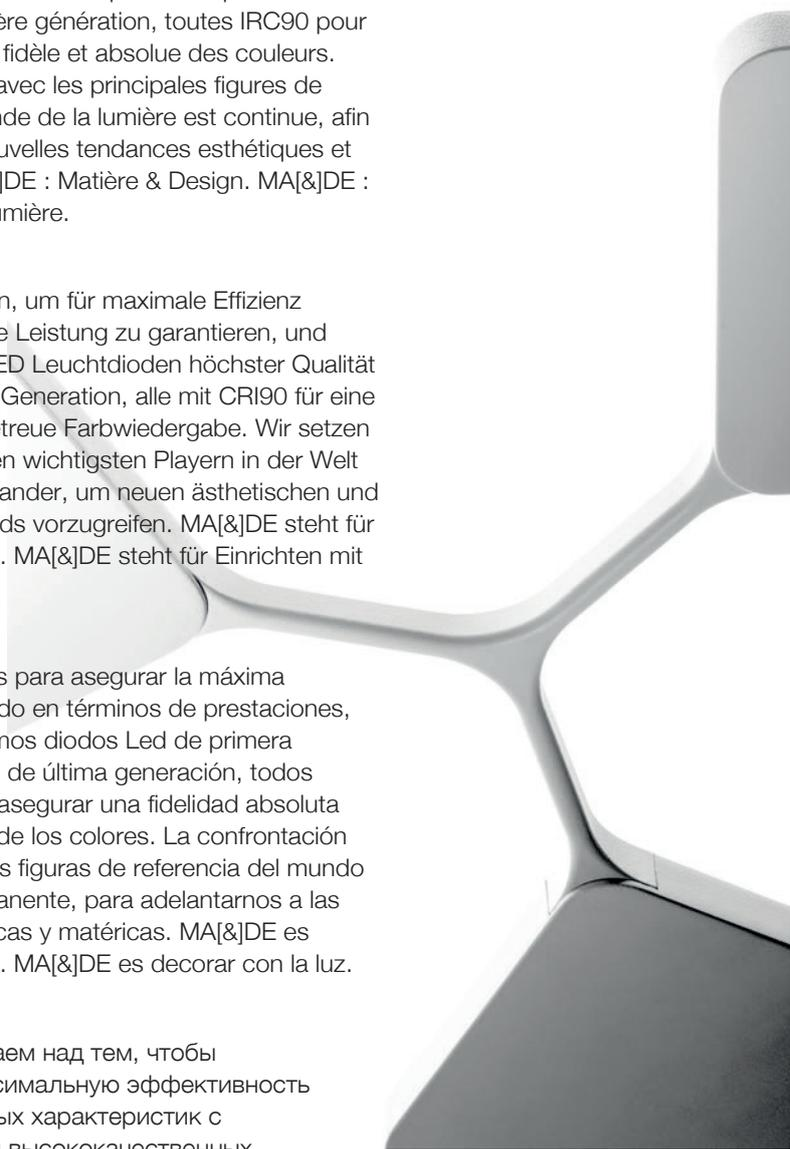



# 5

## YEARS WARRANTY

<sup>IT</sup> — Linea Light Group offre una garanzia di 5 anni sui propri prodotti per vizi di fabbricazione previa compilazione dell'apposito modulo di attivazione, disponibile sul sito [www.linealight.com](http://www.linealight.com). In mancanza di attivazione rimane valida la garanzia prevista per legge. I prodotti devono essere installati tassativamente con alimentazioni, cablaggi e accessori originali del Gruppo Linea Light, o eventualmente approvati dall'azienda. L'utilizzo di accessori non originali, o non approvati, determina il decadimento di ogni garanzia sul prodotto.

Per ulteriori informazioni, consultare il sito [www.linealight.com](http://www.linealight.com)

<sup>EN</sup> — Linea Light Group offers a 5-year warranty on its products against manufacturing defects, subject to filling in the activation form available at [www.linealight.com](http://www.linealight.com). In the absence of activation, the statutory warranty remains valid. All power supply, wiring and accessories used for product installation shall be original Linea Light Group parts or approved by the company. The warranty will become void if non original or non approved parts are used.

For more information, please visit our website [www.linealight.com](http://www.linealight.com)

<sup>FR</sup> — Linea Light Group offre une garantie de 5 ans sur ses produits pour vice de fabrication à condition d'avoir préalablement rempli le formulaire d'activation correspondant, disponible sur le site [www.linealight.com](http://www.linealight.com). En cas de non-activation, la garantie prévue par la loi reste valable. Les produits doivent impérativement être installés avec des alimentations, des câblages et des accessoires Linea Light Group, ou qui ont été approuvés par l'entreprise. L'utilisation d'accessoires non d'origine, ou non approuvés, entraîne la déchéance de toute garantie sur le produit.

Pour tout renseignement complémentaire, consulter le site [www.linealight.com](http://www.linealight.com)

<sup>DE</sup> — Die Firma Linea Light Group gibt eine Garantie von 5 Jahren auf ihre Produkte in Bezug auf Produktionsfehler. Voraussetzung für die Inanspruchnahme der Garantie ist das Ausfüllen des entsprechenden Formulars zur Aktivierung der Garantie, das auf der Webseite [www.linealight.com](http://www.linealight.com) verfügbar ist. Wenn keine Aktivierung der Garantie erfolgt, gilt die gesetzlich vorgeschriebene Garantie. Die Produkte müssen obligatorisch mit Originalstromversorgung, Originalkabeln und Originalzubehör der Linea Light Group oder mit Teilen, die von der Linea Light Group ausdrücklich empfohlen sind, installiert werden. Die Verwendung von nicht originale oder nicht vom Hersteller empfohlenem Zubehör führt zu einem sofortigen Verfall vom Garantieanspruch für das Produkt.

Für weitere Informationen, besuchen Sie bitte [www.linealight.com](http://www.linealight.com)

<sup>ES</sup> — Linea Light Group ofrece una garantía de 5 años para sus productos por vicios de fabricación previa cumplimentación del formulario correspondiente de activación, disponible en el sitio [www.linealight.com](http://www.linealight.com). En caso de no activación, la garantía es la contemplada por la ley. Los productos se han de instalar obligatoriamente con alimentaciones, cableados y accesorios originales de Linea Light Group o, de otra forma, deben ser aprobados por la empresa misma. El uso de accesorios no originales, o no aprobados, anula todas las garantías del producto.

Para más información, visite [www.linealight.com](http://www.linealight.com)

<sup>PY</sup> — Linea Light Group дает 5-летнюю гарантию на свои изделия от дефектов производства после заполнения соответствующего бланка активации, который можно найти на сайте [www.linealight.com](http://www.linealight.com). При отсутствии активации действует предусмотренная законом гарантия. Изделия должны обязательно устанавливаться с оригинальными или одобренными Linea Light Group блоками питания, проводами и аксессуарами. В случае использования неоригинальных или неодобренных производителем аксессуаров гарантия на изделия будет аннулирована.

Еще больше информации на нашем сайте [www.linealight.com](http://www.linealight.com)

# Application Index

## **Pendant luminaires**

- Diphy 011
- Oxygen 025
- Tablet 041
- Quad 057
- La Mariée 069
- Mongolfier 077
- Circle Wave 087
- 2Nights 097
- Lama 111
- Saturn 123
- Kyklos 135
- Square 163
- Entourage 175
- Opti-Line 187
- Mr.Magoo 195
- Xilema 211
- Hinomaru 233
- Madame Blanche 241
- Branch 249
- Monarque 257
- Next 265
- Dunia 299

## **Free standing light**

- Diphy 011
- Oxygen 025
- Tablet 041
- Lama 111
- Mr.Magoo 195
- Xilema 211
- Kimia 225

## **Recessed\_Semi rec. light**

- Diphy 011
- 1Night 097
- Next 265

## **Ceiling luminaires**

- Diphy 011
- Oxygen 025
- Tablet 041
- Circle Wave 087
- Lama 111
- Saturn 123
- Reflexio 147
- Oblix 155
- Square 163
- Mr.Magoo 195
- Xilema 211
- Hinomaru 233
- Next 265
- Flurry 283
- Eclips 291
- Dunia 299
- Dynamic 307

## **Table lamp**

- La Mariée 069
- Lama 111
- Chlorophyll [Bulbo] 331

## **Track luminaires**

- Vertical [Bulbo] 331

## **Wall light**

- Diphy 011
- Oxygen 025
- Tablet 041
- Quad 057
- 2Nights 097
- Lama 111
- Saturn 123
- Kyklos 135
- Reflexio 147
- Oblix 155
- Square 163
- Xilema 211
- Next 265
- Wings 275
- Flurry 283
- Eclips 291
- Dynamic 307
- Moonflower 315

## **Linear profile**

- Thin\_Reika [Bulbo] 331



**Diphy**  
P. 011



**Oxygen**  
P. 025



**Tablet**  
P. 041

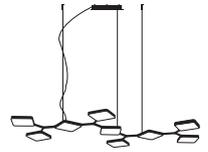

**Quad**  
P. 057



**Lama**  
P. 111



**Saturn**  
P. 123



**Kyklos**  
P. 135



**Reflexio**  
P. 147



**Mr.Magoo**  
P. 195



**Xilema**  
P. 211



**Kimia**  
P. 225



**Hinomaru**  
P. 233



**Wings**  
P. 275



**Flurry**  
P. 283



**Eclips**  
P. 291



**Dunia**  
P. 299

# Product Index



**La Mariée**

P. 069



**Mongolfier**

P. 077



**Circle Wave**

P. 087



**1Night\_2Nights**

P. 097



**Oblix**

P. 155



**Square**

P. 163



**Entourage**

P. 175



**Opti-Line**

P. 187



**Madame Blanche**

P. 241



**Branch**

P. 249



**Monarque**

P. 257



**Next**

P. 265



**Dynamic**

P. 307



**Moonflower**

P. 315



**Bulbo collection**

P. 331

# **Material & Design**

2018

# Diphy

IT — Un prestito dalla botanica, una silhouette leggera. L'estrema trasparenza del diffusore in PMMA fa da contraltare alla luminosità della lampada accesa, impreziosita dal caratteristico pattern di microincisioni al laser (OptiLight Technology™). Una sottilissima barra di alluminio verniciato bianco ospita la sorgente LED.

FR — Un emprunt à la botanique, une silhouette légère. L'extrême transparence du diffuseur en PMMA contraste avec la luminosité de la lampe allumée, rehaussée de micro-incisions au laser (OptiLight Technology™). Une barre très fine en aluminium verni blanc accueille la source LED.

ES — Un préstamo de la botánica, una silueta ligera. La extrema transparencia del difusor en PMMA contrasta la luminosidad de la lámpara encendida, embellecida por el modelo característico de micrograbados al láser (OptiLight Technology™). Una barra muy fina de aluminio pintado de color blanco aloja la fuente LED.

EN — A loan from botany, a slight silhouette. The extreme transparency of the PMMA diffuser is in contrast to the brightness of the lamp lit, embellished with a characteristic micro laser-engraved pattern (OptiLight Technology™). An extra thin white painted aluminum bar houses the LED light source.

DE — Ein Ausflug in die Botanik. Eine Anlehnung an die Botanik mit leichter Silhouette. Die extreme Transparenz des Diffusors aus PMMA bildet einen harmonischen Gegensatz zur Helligkeit der eingeschalteten Leuchte, die durch das charakteristische Muster aus Laser-Mikrogravuren an ästhetischem Wert gewinnt (OptiLight Technology™). In einer sehr schmalen Aluminiumleiste mit Lackierung in Weiß befindet sich die LED-Lichtquelle.

PY — Заимствование из ботаники с легким силуэтом. Исключительная прозрачность рассеивателя из ПММА контрастирует с яркостью включенной лампы, украшенной характерным узором лазерных микронасечек (OptiLight Technology™). В тонкой линейной лампе из выкрашенного в белый цвет алюминия располагается светодиодный светильник.

design **Mirco Crosatto**,  
linealightgroup R&D dept., 2016-2018



reddot award 2017  
winner



2018 | XXV edition

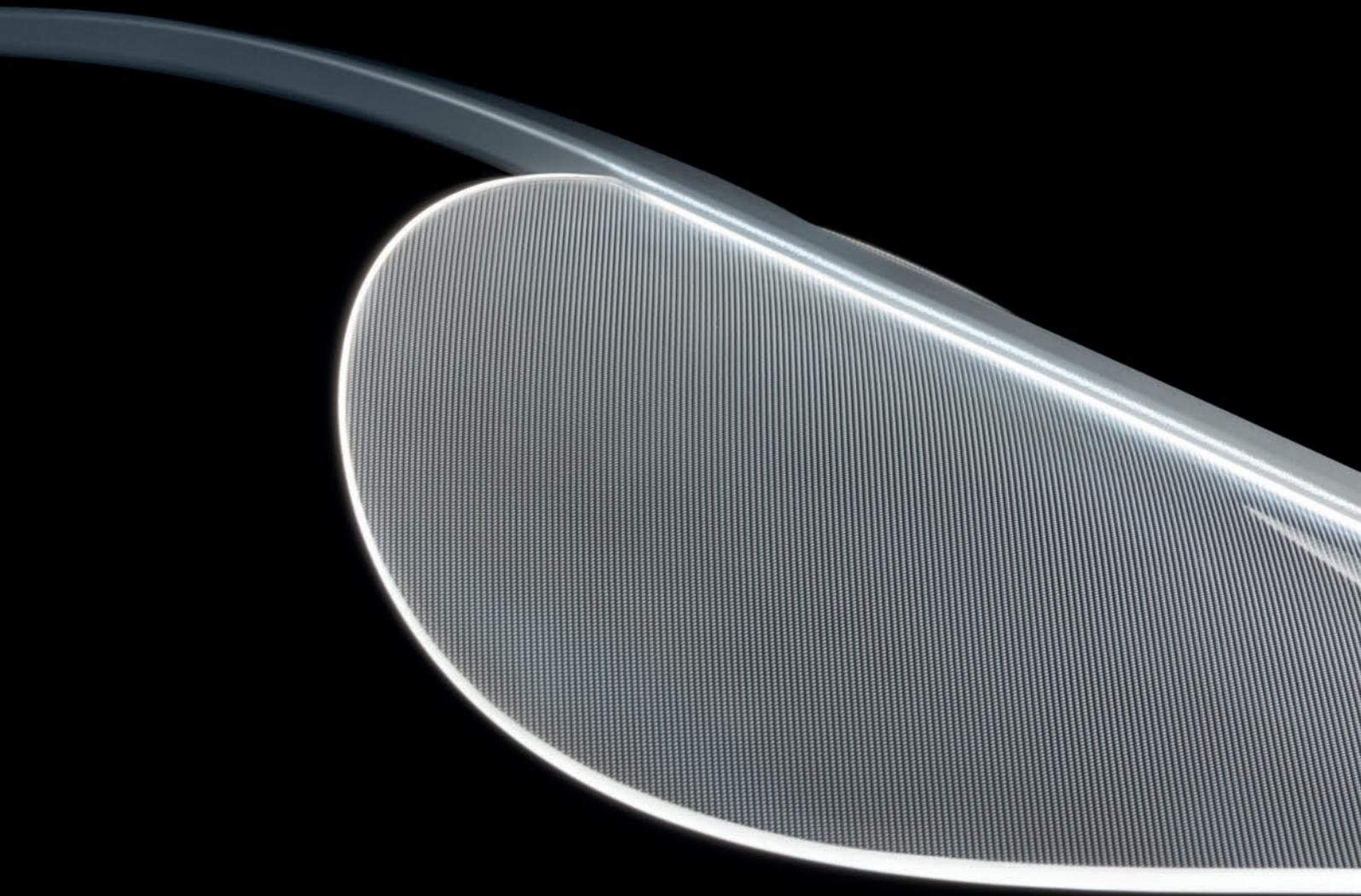





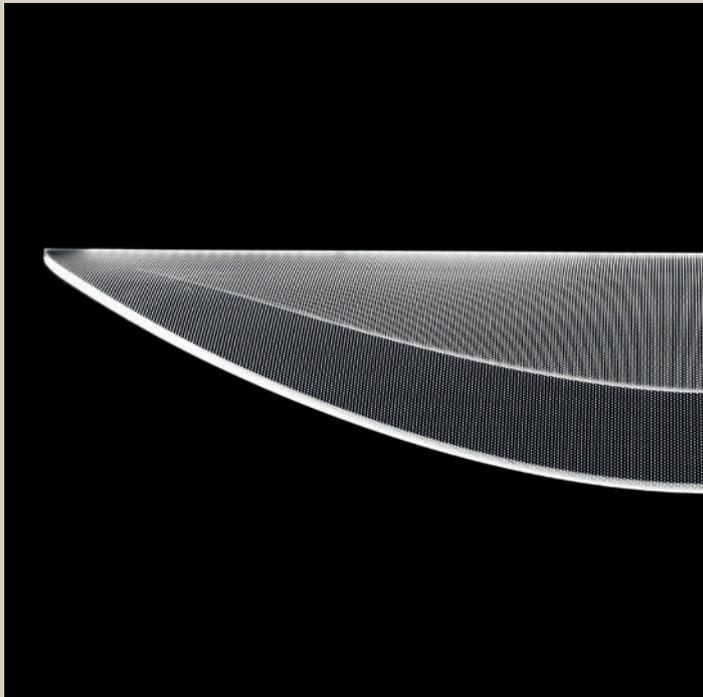









Diphy ceiling luminaires





Diphy free standing light

# Technical Info

Dimensioni e composizioni  
Sizes and compositions  
Dimensions et compositions  
Abmessungen und Zusammensetzung  
Dimensiones y composiciones  
Размеры и композиции

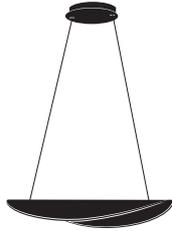



Diphy\_P1 | Pendant luminaires | 220-240 V | topLED 21 W

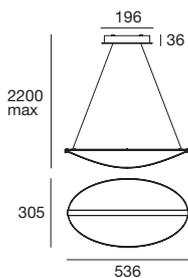

type

White CRI 90 **8172**

colour

3000 K 2938 lm

optics

diffused

accessories



**KIT0080**  
CASAMBI  
Phase-Cut Dimmer  
1-2 art.



**KIT0026**  
Phase-Cut Dimmer  
1-4 art.



Diphy\_P1 | Pendant luminaires | 220-240 V | topLED 40 W

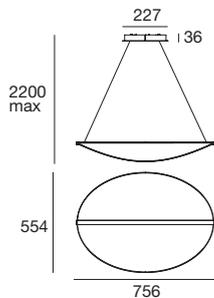

type

White CRI 90 **8173**

colour

3000 K 5794 lm

optics

diffused

accessories



**KIT0080**  
CASAMBI  
Phase-Cut Dimmer  
1 art.



**KIT0026**  
Phase-Cut Dimmer  
1-2 art.



Diphy\_P1 | Pendant luminaires | 220-240 V | topLED 40 W

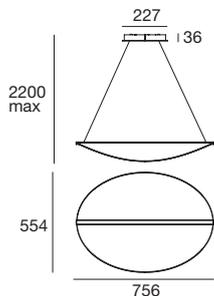

type

White CRI 90 **8170**

colour

3000 K 5239 lm

optics

diffused

accessories



**KIT0079**  
CASAMBI  
DALI Dimmer  
1 art.



Diphy\_PC | Semi-recessed light | 220-240 V | topLED 21 W

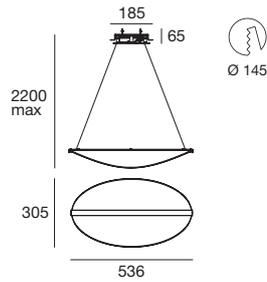

Installabile su cartongesso e superfici in legno.  
 It can be installed on drywall or wood surfaces.  
 Peut être installé sur placoplâtre et des surfaces en bois.  
 Kann auf Gipskarton und Oberflächen aus Holz installiert werden.  
 Instalable en cartón yeso y en superficies de madera.  
 Для установки на гипсокартоне и деревянных поверхностях.

type

White CRI 90 8174

colour

3000 K 2938 lm

optics

diffused

accessories



**KIT0080**  
**CASAMBI**  
 Phase-Cut Dimmer  
 1-2 art.



**KIT0026**  
 Phase-Cut Dimmer  
 1-4 art.

Diphy\_PC | Semi-recessed light | 220-240 V | topLED 40 W

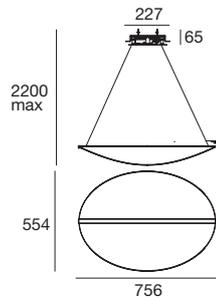

Installabile su cartongesso e superfici in legno.  
 It can be installed on drywall or wood surfaces.  
 Peut être installé sur placoplâtre et des surfaces en bois.  
 Kann auf Gipskarton und Oberflächen aus Holz installiert werden.  
 Instalable en cartón yeso y en superficies de madera.  
 Для установки на гипсокартоне и деревянных поверхностях.

type

White CRI 90 8171

colour

3000 K 5794 lm

optics

diffused

accessories



**KIT0080**  
**CASAMBI**  
 Phase-Cut Dimmer  
 1 art.



**KIT0026**  
 Phase-Cut Dimmer  
 1-2 art.

Diphy\_P3 | Pendant luminaires | 220-240 V | topLED 42 W

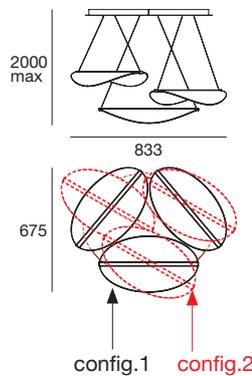

type

White CRI 90 8168

colour

3000 K 5730 lm

optics

diffused

accessories



**KIT0079**  
**CASAMBI**  
 DALI Dimmer  
 1 art.



Diphy\_S | Ceiling-Wall light | 220-240 V | topLED 21 W

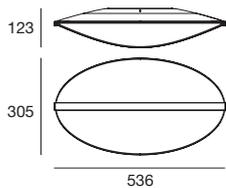

type

White CRI 90 **8166**

colour

3000 K 2938 lm

optics

diffused

accessories



**KIT0080**  
**CASAMBI**  
Phase-Cut Dimmer  
1-2 art.



**KIT0026**  
Phase-Cut Dimmer  
1-4 art.



Diphy\_S | Ceiling-Wall light | 220-240 V | topLED 40 W

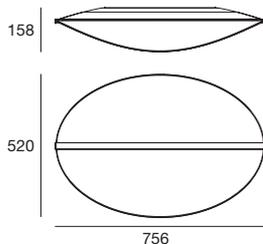

type

White CRI 90 **8167**

colour

3000 K 5794 lm

optics

diffused

accessories



**KIT0080**  
**CASAMBI**  
Phase-Cut Dimmer  
1 art.



**KIT0026**  
Phase-Cut Dimmer  
1-2 art.



Diphy\_FL | Free standing light | 220-240 V | topLED 30 W

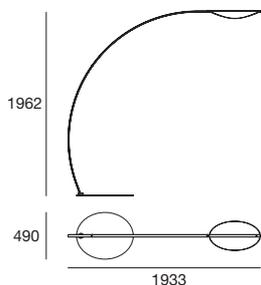

type

White CRI 90 **8165**

colour

3000 K 3743 lm

optics

diffused

# Oxygen

IT — Tante varianti dalla geometria archetipica e riconoscibile. Come un leggero anello di aria e luce, il vivace paralume in poliuretano abbraccia il diffusore circolare in PMMA, invisibile a luce spenta. A lampada accesa, l'elegante trama dell'OptiLight Technology™ ne enfatizza l'estetica.

FR — De nombreuses variantes à la géométrie archétypale et reconnaissable. Comme un léger anneau d'air et de lumière, le vif abat-jour en polyuréthane embrasse le diffuseur circulaire en PMMA, invisible quand la lumière est éteinte. Quand la lampe est allumée, l'élégante trame de l'OptiLight Technology™ souligne son esthétique.

ES — Numerosas variantes de la geometría arquetípica y reconocible. Como un anillo ligero de aire y luz, la pantalla alegre de poliuretano envuelve el difusor circular de PMMA, invisible con la luz apagada. Con la lámpara encendida, la elegante trama de la OptiLight Technology™ enfatiza su estética.

EN — Available in different options, all sharing an archetypic and recognizable geometry. Like an air and light slight ring, this vibrant polyurethane lampshade encompasses the round diffuser made of PMMA, which is completely invisible when light is off. When light is on, the elegant weave created by the OptiLight Technology™ emphasizes its aesthetics.

DE — Viele Varianten einer archetypischen Geometrie mit einem hohen Wiedererkennungswert. Wie ein leichter Ring aus Luft und Licht umarmt der lebhaftes Lampenschirm aus PU den runden Diffusor aus PMMA, der bei ausgeschaltetem Licht unsichtbar wird. Bei eingeschalteter Leuchte betont die elegante Struktur der OptiLight Technology™ die Ästhetik.

PY — Множество вариантов узнаваемой архетипной формы. Подобно легкому кольцу воздуха и света игривый абажур из полиуретана таит в себе круглый рассеиватель из ПММА, невидимый при выключенном свете. При включенном светильнике элегантно плетение OptiLight Technology™ подчеркивает его внешний вид.

design **Pio & Tito Toso**, 2016-2018



**reddot** award 2017  
winner

















Oxygen ceiling luminaires









Oxygen free standing light

# Technical Info

Dimensioni e composizioni  
Sizes and compositions  
Dimensions et compositions  
Abmessungen und Zusammensetzung  
Dimensiones y composiciones  
Размеры и композиции





Oxygen\_P | Pendant luminaires | 220-240 V | topLED 36 W

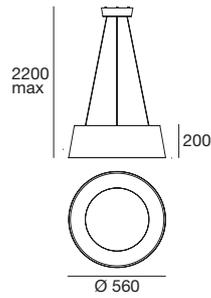

type

Wh.	Wh.	CRI 90	<b>8089</b>
Bl.	Wh.	CRI 90	<b>8090</b>
Yel.	Wh.	CRI 90	<b>8091</b>
Azul	Wh.	CRI 90	<b>8092</b>

colour

3000 K 4042 lm

optics

diffused

accessories



KIT0079

CASAMBI  
DALI Dimmer  
1 art.



Oxygen\_P | Pendant luminaires | 220-240 V | topLED 50 W

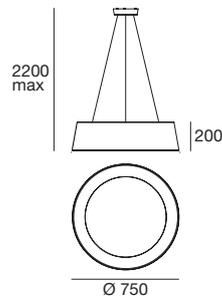

type

Wh.	Wh.	CRI 90	<b>8093</b>
Bl.	Wh.	CRI 90	<b>8094</b>
Yel.	Wh.	CRI 90	<b>8095</b>
Azul	Wh.	CRI 90	<b>8096</b>

colour

3000 K 5670 lm

optics

diffused

accessories



KIT0079

CASAMBI  
DALI Dimmer  
1 art.



Oxygen\_S | Ceiling luminaires | 220-240 V | topLED 36 W

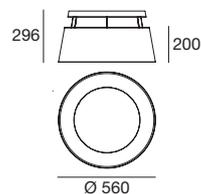

type

Wh.	Wh.	CRI 90	<b>8081</b>
Bl.	Wh.	CRI 90	<b>8082</b>
Yel.	Wh.	CRI 90	<b>8083</b>
Azul	Wh.	CRI 90	<b>8084</b>

colour

3000 K 4042 lm

optics

diffused

accessories



KIT0079

CASAMBI  
DALI Dimmer  
1 art.



Oxygen\_S | Ceiling luminaires | 220-240 V | topLED 50 W

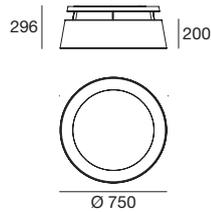

type

Wh.	Wh.	CRI 90	<b>8085</b>
Bl.	Wh.	CRI 90	<b>8086</b>
Yel.	Wh.	CRI 90	<b>8087</b>
Azu.	Wh.	CRI 90	<b>8088</b>

colour

3000 K 5670 lm

optics

diffused

accessories



KIT0079

CASAMBI  
DALI Dimmer  
1 art.



Oxygen\_W1 | Wall light | 220-240 V | topLED 17 W



type

Wh.	Wh.	CRI 90	<b>8185</b>
Bl.	Wh.	CRI 90	<b>8186</b>
Yel.	Wh.	CRI 90	<b>8187</b>
Azu.	Wh.	CRI 90	<b>8188</b>

colour

3000 K 2021 lm

optics

diffused

accessories



KIT0079

CASAMBI  
DALI Dimmer  
1 art.



Oxygen\_W1 | Wall light | 220-240 V | topLED 17 W

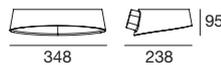

type

Wh.	Wh.	CRI 90	<b>8495</b>
Bl.	Wh.	CRI 90	<b>8496</b>
Yel.	Wh.	CRI 90	<b>8497</b>
Azu.	Wh.	CRI 90	<b>8498</b>

colour

3000 K 2021 lm

optics

diffused

accessories



KIT0080

CASAMBI  
Phase-Cut Dimmer  
1-2 art.



KIT0026

Phase-Cut Dimmer  
1-5 art.

Oxygen\_W2 | Wall light | 220-240 V | topLED 36 W

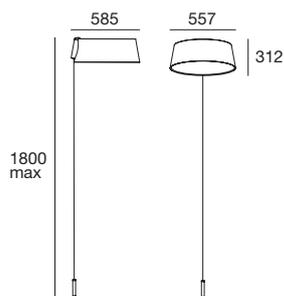

type

Wh.	Wh.	CRI 90	<b>8189</b>
Bl.	Wh.	CRI 90	<b>8190</b>
Yel.	Wh.	CRI 90	<b>8191</b>
Azul	Wh.	CRI 90	<b>8192</b>

colour

3000 K 4042 lm

optics

diffused



Oxygen\_FL1 | Free standing light | 220-240 V | topLED 36 W

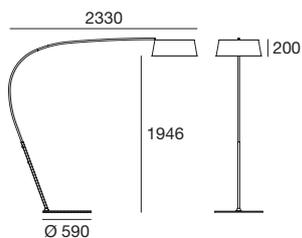

type

Wh.	Wh.	CRI 90	<b>8101</b>
Bl.	Wh.	CRI 90	<b>8102</b>
Yel.	Wh.	CRI 90	<b>8103</b>
Azul	Wh.	CRI 90	<b>8104</b>

colour

3000 K 4042 lm

optics

diffused



Oxygen\_FL2 | Free standing light | 220-240 V | topLED 36 W

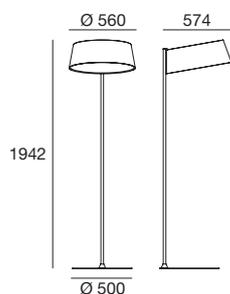

type

Wh.	Wh.	CRI 90	<b>8097</b>
Bl.	Wh.	CRI 90	<b>8098</b>
Yel.	Wh.	CRI 90	<b>8099</b>
Azul	Wh.	CRI 90	<b>8100</b>

colour

3000 K 4042 lm

optics

diffused



# Tablet

<sup>IT</sup> — Una luce nitida, radente o diffusa disposta su un asse girevole. Il supporto in alluminio consente l'orientamento della sorgente e del fascio luminoso, garantendo una rotazione completa, per una luce d'accento o espansa. Tablet è luce mai ferma, disponibile in diverse varianti, in finitura bianca o nera.

<sup>FR</sup> — Une lumière nette, rasante ou diffuse disposée sur un axe pivotant. Le support en aluminium permet l'orientation de la source et du faisceau lumineux, garantissant une rotation complète, pour une lumière accentuée ou diffuse. Tablet est une lumière jamais immobile, disponible dans différentes versions, avec une finition blanche ou noire.

<sup>ES</sup> — Una luz nítida, rasante o difusa sobre un eje giratorio. El soporte de aluminio permite orientar la fuente y el haz luminoso al garantizar una rotación completa, para proyectar una luz localizada o expandida. Tablet es luz siempre en movimiento, disponible en distintas variantes, con acabado en blanco o negro.

<sup>EN</sup> — A clear, grazing or diffusive lighting, displaced on turning axis. The aluminum support allows light beams and source orientation, granting a complete rotation and creating accent or wide lighting. Tablet is light always on the move. It is available in different versions, both in white or black finish.

<sup>DE</sup> — Ein klares, gerichtetes oder diffuses Licht, angeordnet auf einer Drehachse. Die Halterung aus Aluminium erlaubt das Ausrichten von Lichtquelle und Lichtstrahl und die komplette Rotation der Leuchte, für eine Akzentbeleuchtung oder ein breitflächiges Licht. Tablet ist Licht, das niemals stillsteht, und in verschiedenen Ausführungen mit weißer oder schwarzer Oberfläche erhältlich.

<sup>PY</sup> — Четкий скользящий или рассеянный свет, располагающийся на крутящейся оси. Алюминиевая опора позволяет поворачивать источник света и световой пучок, обеспечивая полное вращение для направленного или рассеянного освещения. Tablet – это свет в постоянном движении, который предлагается в различных вариантах с белой или черной отделкой.

design **Mirco Crosatto**,  
linealightgroup R&D dept., 2014-2018



reddot award 2018  
winner

product: **Tablet\_FL**



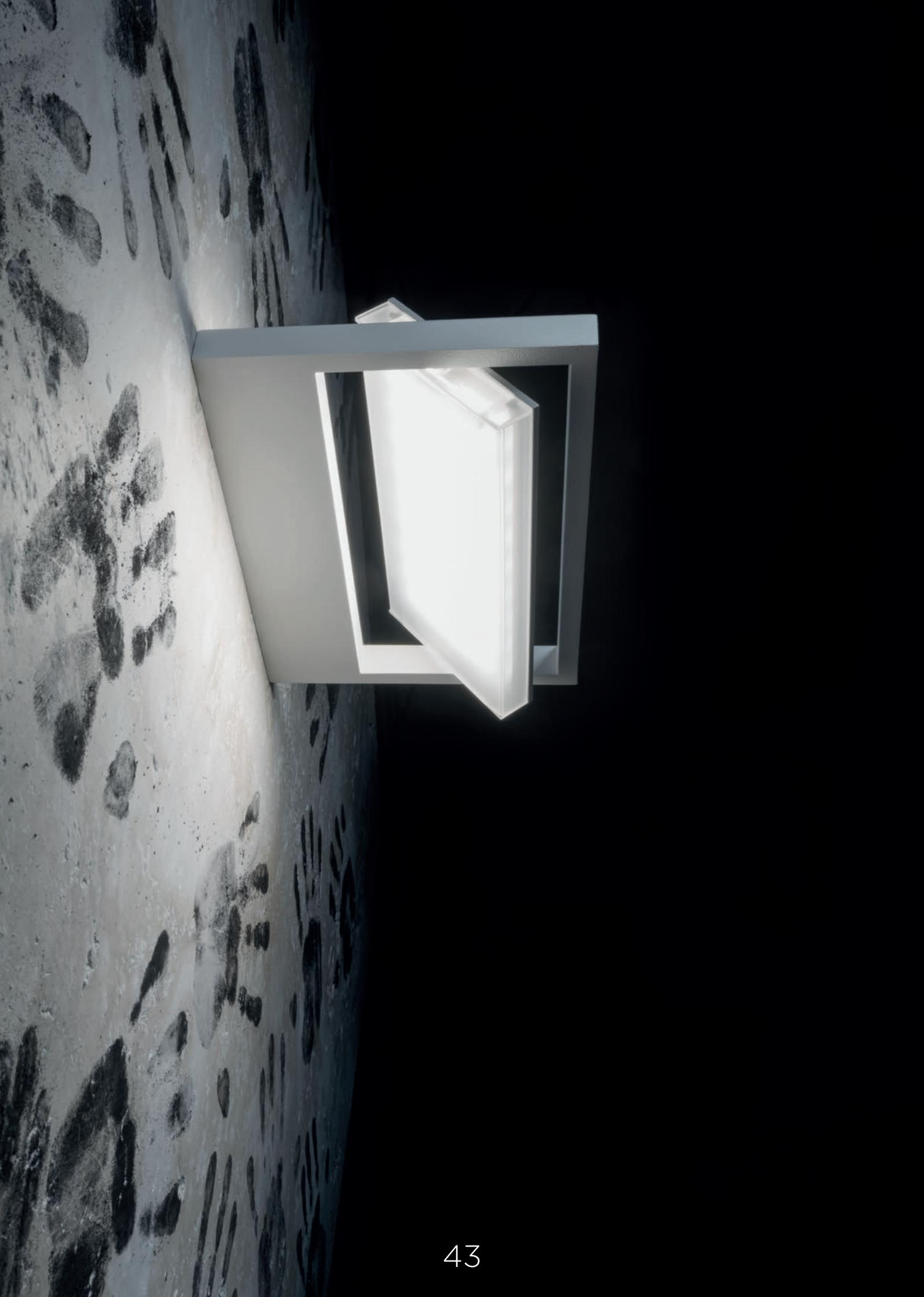



Tablet pendant luminaires









Tablet ceiling luminaires









# Technical Info

Dimensioni e composizioni  
Sizes and compositions  
Dimensions et compositions  
Abmessungen und Zusammensetzung  
Dimensiones y composiciones  
Размеры и композиции



**Tablet\_PX** | Pendant luminaires | 220-240 V | topLED 46 W

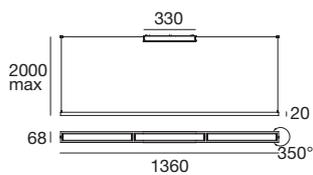

**type**

White	CRI 90	<b>8450</b>
Black	CRI 90	<b>8451</b>

**colour**

3000 K 5010 lm

**optics**

diffused

**accessories**



**KIT0080**  
CASAMBI  
Phase-Cut Dimmer  
1 art.



**KIT0026**  
Phase-Cut Dimmer  
1-2 art.

**Tablet\_P1** | Pendant luminaires | 220-240 V | topLED 23 W

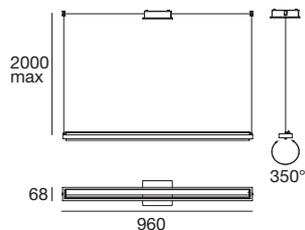

**type**

White	CRI 90	<b>8475</b>
Black	CRI 90	<b>8476</b>

**colour**

3000 K 2719 lm

**optics**

diffused

**accessories**



**KIT0080**  
CASAMBI  
Phase-Cut Dimmer  
1-2 art.



**KIT0026**  
Phase-Cut Dimmer  
1-4 art.

**Tablet\_P2** | Pendant luminaires | 220-240 V | topLED 41 W

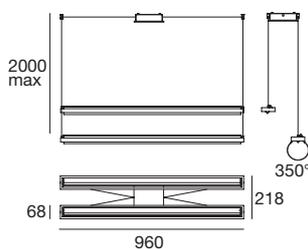

**type**

White	CRI 90	<b>8478</b>
Black	CRI 90	<b>8479</b>

**colour**

3000 K 5163 lm

**optics**

diffused

**accessories**



**KIT0080**  
CASAMBI  
Phase-Cut Dimmer  
1 art.



**KIT0026**  
Phase-Cut Dimmer  
1-2 art.

**Tablet\_S** | Ceiling luminaires | 220-240 V | topLED 26 W

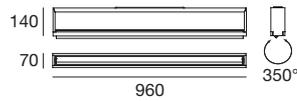

**type**

White	CRI 90	<b>7595</b>
Black	CRI 90	<b>7596</b>

**colour**

3000 K 3118 lm

**optics**

diffused

**Tablet\_W2** | Wall light | 220-240 V | topLED 19 W

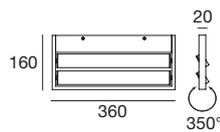

**type**

White	CRI 90	<b>7606</b>
Black	CRI 90	<b>7613</b>

**colour**

3000 K 2520

**optics**

diffused

**suggested accessories**



**KIT0046**  
Fixing bracket only for 7606



**KIT0047**  
Fixing bracket only for 7613

**Tablet\_W2** | Wall light | 220-240 V | topLED 38 W

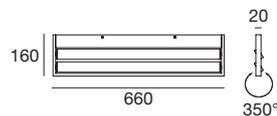

**type**

White	CRI 90	<b>7607</b>
Black	CRI 90	<b>7614</b>

**colour**

3000 K 5040 lm

**optics**

diffused

**suggested accessories**



**KIT83**  
Fixing bracket only for 7607



**KIT0044**  
Fixing bracket only for 7614



Tablet\_W1 | Wall light | 220-240 V | topLED 5 W

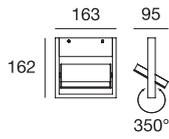

**type**

White	CRI 90	<b>7600</b>
Black	CRI 90	<b>7608</b>

**colour**

3000 K 557 lm

**optics**

diffused

**suggested accessories**



**KIT80**

Fixing bracket only for 7600



**KIT0041**

Fixing bracket only for 7608

Tablet\_W1 | Wall light | 220-240 V | topLED 19 W

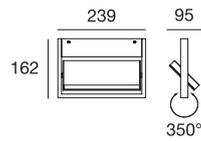

**type**

White	CRI 90	<b>7601</b>
Black	CRI 90	<b>7609</b>

**colour**

3000 K 2204 lm

**optics**

diffused

**suggested accessories**



**KIT81**

Fixing bracket only for 7601



**KIT0042**

Fixing bracket only for 7609

Tablet\_W1 | Wall light | 220-240 V | topLED 19 W

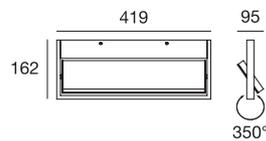

**type**

White	CRI 90	<b>7602</b>
Black	CRI 90	<b>7610</b>

**colour**

3000 K 2417 lm

**optics**

diffused

**suggested accessories**



**KIT82**

Fixing bracket only for 7602



**KIT0043**

Fixing bracket only for 7610

**Tablet\_W1** | Wall light | 220-240 V | topLED 19 W

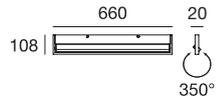
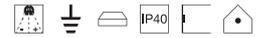

**type**

White	CRI 90	<b>7604</b>
Black	CRI 90	<b>7611</b>

**colour**

3000 K 2520 lm

**optics**

diffused

**suggested accessories**



**KIT83**

Fixing bracket only for 7604

**KIT0044**

Fixing bracket only for 7611

**Tablet\_W1** | Wall light | 220-240 V | topLED 26 W

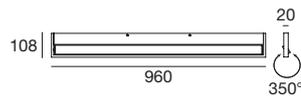

**type**

White	CRI 90	<b>7605</b>
Black	CRI 90	<b>7612</b>

**colour**

3000 K 3118 lm

**optics**

diffused

**suggested accessories**

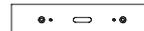

**KIT84**

Fixing bracket only for 7605

**KIT0045**

Fixing bracket only for 7612

**Tablet\_FL** | Free standing light | 220-240 V | topLED 36 W

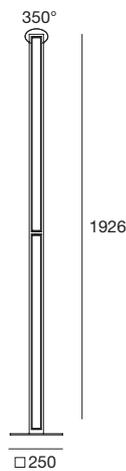

**type**

White	CRI 90	<b>8452</b>
Black	CRI 90	<b>8453</b>

**colour**

3000 K 4470 lm

**optics**

diffused



Tablet | fixing bracket

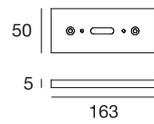

type

White	<b>KIT80</b>
Black	<b>KIT0041</b>

suitable for

7600
7608

Tablet | fixing bracket

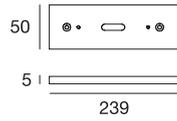

type

White	<b>KIT81</b>
Black	<b>KIT0042</b>

suitable for

7601
7609

Tablet | fixing bracket

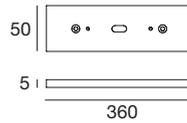

type

White	<b>KIT0046</b>
Black	<b>KIT0047</b>

suitable for

7606
7613

Tablet | fixing bracket

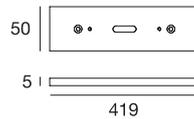

type

White	<b>KIT82</b>
Black	<b>KIT0043</b>

suitable for

7602
7610

Tablet | fixing bracket

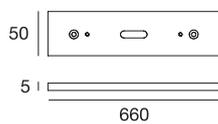

type

White	<b>KIT83</b>
Black	<b>KIT0044</b>

suitable for

7604-7607
7611-7614

Tablet | fixing bracket

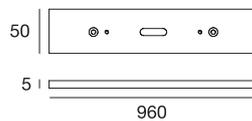

type

White	<b>KIT84</b>
Black	<b>KIT0045</b>

suitable for

7605
7612

# Quad

<sup>IT</sup> — Semplicità modulare. Quadrati che scivolano l'uno sull'altro, fondendosi ad angolo retto, oppure strutture a sospensione plastiche e geometriche. Il corpo in alluminio pressofuso ospita la sorgente LED, le forme semplici e stondate sono una sintesi perfetta tra dinamicità e morbidezza.

<sup>FR</sup> — Simplicité modulaire. Des carrés qui glissent l'un sur l'autre et qui fusionnent à angle droit ou des structures en suspension plastiques et géométriques. Le corps en aluminium moulé sous pression accueille la source LED. Ses formes simples et arrondies sont une synthèse parfaite entre dynamisme et douceur.

<sup>ES</sup> — Sencillez modular. Cuadrados, que se deslizan unos sobre otros, fundiéndose en ángulo recto, o estructuras colgantes plásticas y geométricas. El cuerpo de aluminio moldeado a presión aloja la fuente LED; las formas sencillas y redondeadas son una síntesis perfecta entre dinamicidad y suavidad.

<sup>EN</sup> — Modular simplicity. Shifting squares merging at right angle or plastic and geometric suspensions. The die-cast aluminium casing holds the LED source, with its rounded and simple shapes. A perfect synthesis between dynamicity and smoothness.

<sup>DE</sup> — Modulare Schlichtheit. Quadrate, die sich in rechten Winkeln übereinander schieben oder plastische, geometrische hängende Strukturen. Das Gehäuse aus Aluminiumdruckguss, in dem sich die LED Lichtquelle befindet, ist mit seinem einfachen und abgerundeten Design die perfekte Synthese von Dynamik und sanft geschwungenen Formen.

<sup>PY</sup> — Модульная простота Два квадрата, скользящие по направлению друг к другу и сливающиеся под прямым углом в одно целое, или же пластичные геометрические подвесные конструкции. В литом под давлением алюминиевом корпусе располагается светодиодный источник, простые закругленные формы которого представляют собой идеальную комбинацию динамичности и мягкости.

design **Pio & Tito Toso**, 2014-2018







Quad wall light







Quad pendant luminaires





# Technical Info

Dimensioni e composizioni  
Sizes and compositions  
Dimensions et compositions  
Abmessungen und Zusammensetzung  
Dimensiones y composiciones  
Размеры и композиции



Quad\_P3 | Pendant luminaires | 220-240 V | topLED 42 W

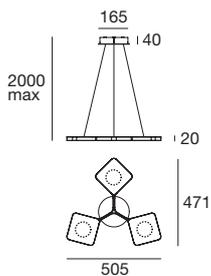

type

White	CRI 90	<b>8116</b>
Black	CRI 90	<b>8117</b>

colour

3000 K 4173 lm

optics

diffused

accessories



**KIT0080**  
**CASAMBI**  
Phase-Cut Dimmer  
1 art.



**KIT0026**  
Phase-Cut Dimmer  
1-2 art.

Quad\_P7 | Pendant luminaires | 220-240 V | topLED 42 W

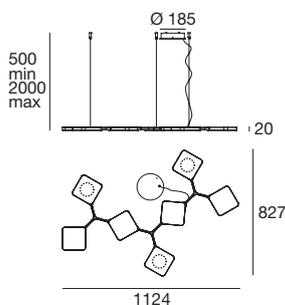

type

White	CRI 90	<b>8520</b>
Black	CRI 90	<b>8521</b>

colour

3000 K 4173 lm

optics

diffused

accessories



**KIT0080**  
**CASAMBI**  
Phase-Cut Dimmer  
1 art.



**KIT0026**  
Phase-Cut Dimmer  
1-2 art.

Quad,  
pendant luminaires



Quad\_P9 | Pendant luminaires | 220-240 V | topLED 91 W

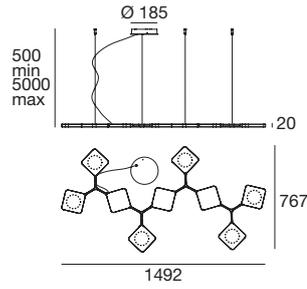

type

White	CRI 90	<b>8110</b>
Black	CRI 90	<b>8111</b>

colour

3000 K 9160 lm

optics

diffused

accessories



**KIT0079**  
**CASAMBI**  
 DALI Dimmer  
 1 art.



Quad\_P12 | Pendant luminaires | 220-240 V | topLED 91 W

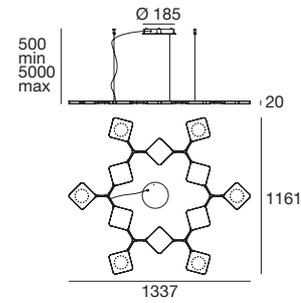
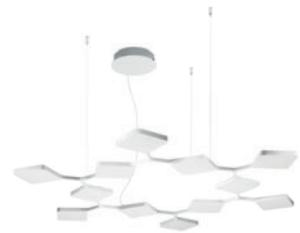

type

White	CRI 90	<b>8112</b>
Black	CRI 90	<b>8113</b>

colour

3000 K 9160 lm

optics

diffused

accessories



**KIT0079**  
**CASAMBI**  
 DALI Dimmer  
 1 art.



Quad,  
 pendant luminaires



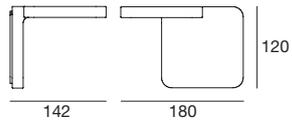

**type**

White	CRI 90	<b>7750</b>
Black	CRI 90	<b>7753</b>

**colour**

3000 K 1530 lm

**optics**

diffused

**accessories**



**KIT0080**  
**CASAMBI**  
Phase-Cut Dimmer  
1-2 art.



**KIT0026**  
Phase-Cut Dimmer  
1-5 art.



# La Mariée

IT — Globi eterei soffusamente illuminati. La luce diviene tutt'uno con il vetro soffiato, gioca con i riflessi delle forme curvilinee e con i diversi colori. Diffusore trasparente, fumé oppure ramato per lampade fortemente espressive, piccoli spozalizi di luce e materia.

FR — Des globes éthérés doucement éclairés. La lumière ne fait qu'une avec le verre soufflé, elle joue avec les reflets des formes curvilignes et les différentes couleurs. Diffuseur transparent, fumé ou cuivré pour des lampes fortement expressives, de petits mariages entre lumière et matière.

ES — Globos etéreos teñidos de luz. La luz se integra en el vidrio soplado, juega con los reflejos de las formas curvilíneas y con los varios colores. Difusor transparente, ahumado o cobrizo, para lámparas sumamente expresivas, pequeñas uniones de luz y materia.

EN — Softly lit ethereal globes. The light becomes one with the blown glass, creating effects through the reflections of curvilinear shapes and different colours. Transparent, smoked or copper diffuser for highly expressive luminaires, where light and material meet.

DE — Ätherische Kugeln, die gedämpftes Licht abstrahlen. Das Licht wird eins mit dem mundgeblasenen Glas und spielt mit den Reflexionen der geschwungenen Formen und den verschiedenen Farben. Ein Diffusor in der transparenten Ausführung, rauchgrau oder kupferfarben für extrem ausdrucksstarke Leuchten, bei denen Licht und Materie zu einer Einheit verschmelzen.

PY — Мягко освещенные воздушные шары. Свет становится единым целым с дутым стеклом, играя с отблесками изогнутых форм и различными цветами. Прозрачный, дымчатый или медный рассеиватель придает особую выразительность этим маленьким светильникам, объединившим в себе свет и материю.

design **Mirco Crosatto**,  
linealightgroup R&D dept., 2018









La Mariée pendant luminaires





# Technical Info

Dimensioni e composizioni  
Sizes and compositions  
Dimensions et compositions  
Abmessungen und Zusammensetzung  
Dimensiones y composiciones  
Размеры и композиции



La Mariée\_P | Pendant luminaires | 220-240 V | topLED 9 W

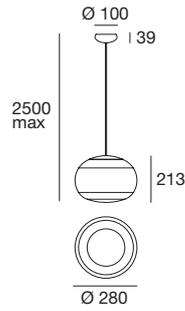

type

Transp.	CRI 90	<b>8625</b>
Smoke G.	CRI 90	<b>8626</b>
Copper G.	CRI 90	<b>8627</b>

colour

3000 K 1008 lm

optics

diffused

accessories



**KIT0080**  
**CASAMBI**  
 Phase-Cut Dimmer  
 1-5 art.



**KIT0026**  
 Phase-Cut Dimmer  
 1-11 art.



La Mariée\_tab | Table lamp | 220-240 V | topLED 9 W

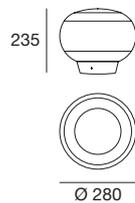

type

Transp.	CRI 90	<b>8628</b>
Smoke G.	CRI 90	<b>8629</b>
Copper G.	CRI 90	<b>8630</b>

colour

3000 K 1008 lm

optics

diffused

# Mongolfier

<sup>IT</sup> — Raffinata leggerezza di linee avvolgenti. Una struttura organica che si avvolge su sé stessa, in metallo verniciato nero opaco oppure con finitura lucida nickel nero e oro rosa. Grazie alla tecnologia di dimmerazione Warm Tune™ la luce varia contemporaneamente in intensità e temperatura colore, seguendo le esigenze ambientali.

<sup>FR</sup> — Légèreté raffinée de lignes enveloppantes. Une structure organique qui s'enveloppe sur elle-même, en métal verni noir opaque ou avec finition brillante nickel noir et or rose. Grâce à la technologie de variation Warm Tune™, la lumière varie en même temps d'intensité et de température de couleur, selon les besoins de l'espace.

<sup>ES</sup> — Ligereza refinada de líneas envolventes. Una estructura orgánica, que se enrolla sobre sí misma, de metal pintado negro mate o con un acabado brillante níquel negro u oro rosa. Con la tecnología de regulación Warm Tune™, la luz cambia al mismo tiempo en intensidad y temperatura color para adaptarse a las exigencias ambientales.

<sup>EN</sup> — Refined lightness wrapping lines. Organic self-wrapped structure, available in two finishes: matt black coated metal or black and pink gold nickel glossy finish. Thanks to the LED Warm Tune™ dimmable technology the light varies intensity and color temperature simultaneously, following all the needs of interior designers.

<sup>DE</sup> — Elegante Leichtigkeit umhüllender Linien. Eine organische Struktur, die um sich selbst gewickelt ist, aus Metall mit Lackierung in Mattschwarz oder mit glänzender Oberfläche in schwarzem Nickel oder Rotgold. Durch die Warm Tune™ Dimmer-Technologie können sowohl Intensität als auch Farbtemperatur des Lichts gleichzeitig geändert und so an die Anforderungen der Umgebung angepasst werden.

<sup>PY</sup> — Изысканная легкость уютных линий. Конструкция органичной формы, замкнутая сама на себе и изготовленная из металла, выкрашенного матовой темной краской или с блестящей отделкой из черного никеля или розового золота. Благодаря технологии регуляции яркости света Warm Tune™ свет меняет одновременно интенсивность и цветовую температуру в зависимости от потребностей освещения обстановки.

design **linealight**group R&D dept., 2016-2018







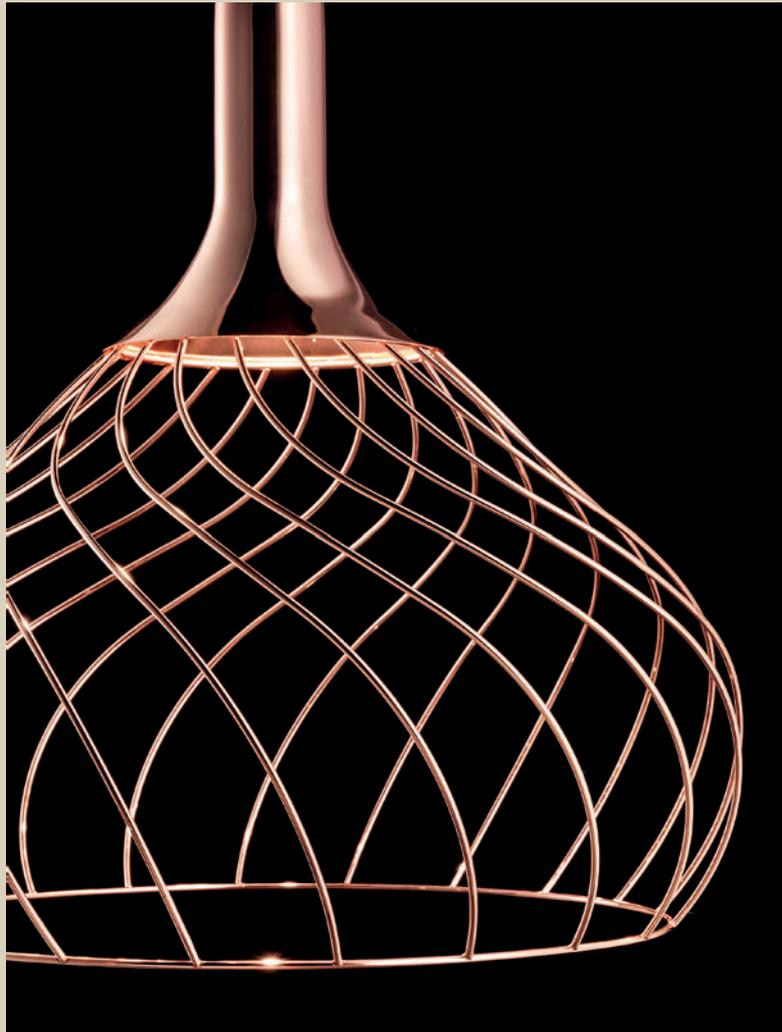





@ 100%







## Technical Info

Dimensioni e composizioni  
Sizes and compositions  
Dimensions et compositions  
Abmessungen und Zusammensetzung  
Dimensiones y composiciones  
Размеры и композиции





Mongolfier\_P1 | Pendant luminaires | 220-240 V | arrayLED 16 W

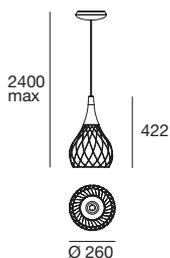

type

Black	CRI 90	8140
Rose G.	CRI 90	8141
Bl. Nic.	CRI 90	8142

colour

Warm Tune 1000 lm

optics

diffused

accessories



**KIT0080**  
**CASAMBI**  
Phase-Cut Dimmer  
1-3 art.



**KIT0026**  
Phase-Cut Dimmer  
1-6 art.



Mongolfier\_P2 | Pendant luminaires | 220-240 V | arrayLED 16 W

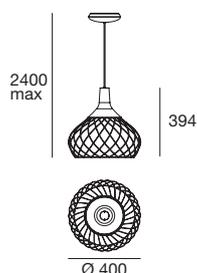

type

Black	CRI 90	8144
Rose G.	CRI 90	8145
Bl. Nic.	CRI 90	8146

colour

Warm Tune 1000 lm

optics

diffused

accessories



**KIT0080**  
**CASAMBI**  
Phase-Cut Dimmer  
1-3 art.



**KIT0026**  
Phase-Cut Dimmer  
1-6 art.



Mongolfier\_P3 | Pendant luminaires | 220-240 V | arrayLED 28 W

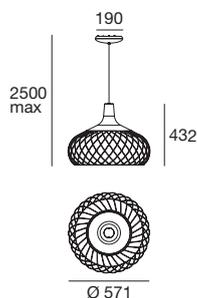

type

Black	CRI 90	8147
Rose G.	CRI 90	8148
Bl. Nic.	CRI 90	8149

colour

Warm Tune 2430 lm

optics

diffused

accessories



**KIT0080**  
**CASAMBI**  
Phase-Cut Dimmer  
1 art.



**KIT0026**  
Phase-Cut Dimmer  
1-3 art.



# Circle Wave

IT — L'incresparsi delle onde viene congelato e trasformato in un disco di luce. Il corpo è in alluminio bianco, il doppio guscio del diffusore è in PMMA termoformato satinato bianco. Una miscela di trasparenze e sfumature affiora dalla luce calda morbidamente diffusa.

FR — Le mouvement des vagues s'imprime et se transforme en disque lumineux. Le corps est en aluminium blanc, la double coquille du diffuseur est en PMMA thermoformé satiné blanc. Un mélange de transparences et de nuances, effleuré par la lumière chaude, douce et diffuse.

ES — Las olas encrespadas se congelan y transforman en un disco de luz. El cuerpo es de aluminio blanco, la carcasa doble del difusor es de PMMA termoformado, satinado en blanco. Una mezcla de transparencias y matices aflora de la luz cálida suavemente difusa.

EN — Waves rippling is frozen and turned into a lighting disc. Aluminum casing in matt white finish and white PMMA thermoformed satin-finished double shell. A transparency and shading mixture derives from the diffusive and smooth lighting.

DE — Der Schwung der Wellen wird eingefangen und in eine Scheibe aus Licht verwandelt. Das Gehäuse ist aus weißem Aluminium, die doppelte Hülle des Diffusors aus thermogeformtem PMMA mit satiniertes, weißer Oberfläche. Eine Mischung aus Transparenz und Nuancen und schafft ein weiches, warmes und diffuses Licht.

PY — Волнистая рябь, застывшая и превратившаяся в световой диск. Корпус из белого алюминия, двойная оболочка рассеивателя из горячеформованного сатинированного белого ПММА. Теплый и мягкий рассеянный свет создает микс прозрачных элементов и оттенков.

design **Mirco Crosatto**,  
linealightgroup R&D dept., 2012







Circle Wave pendant luminaires



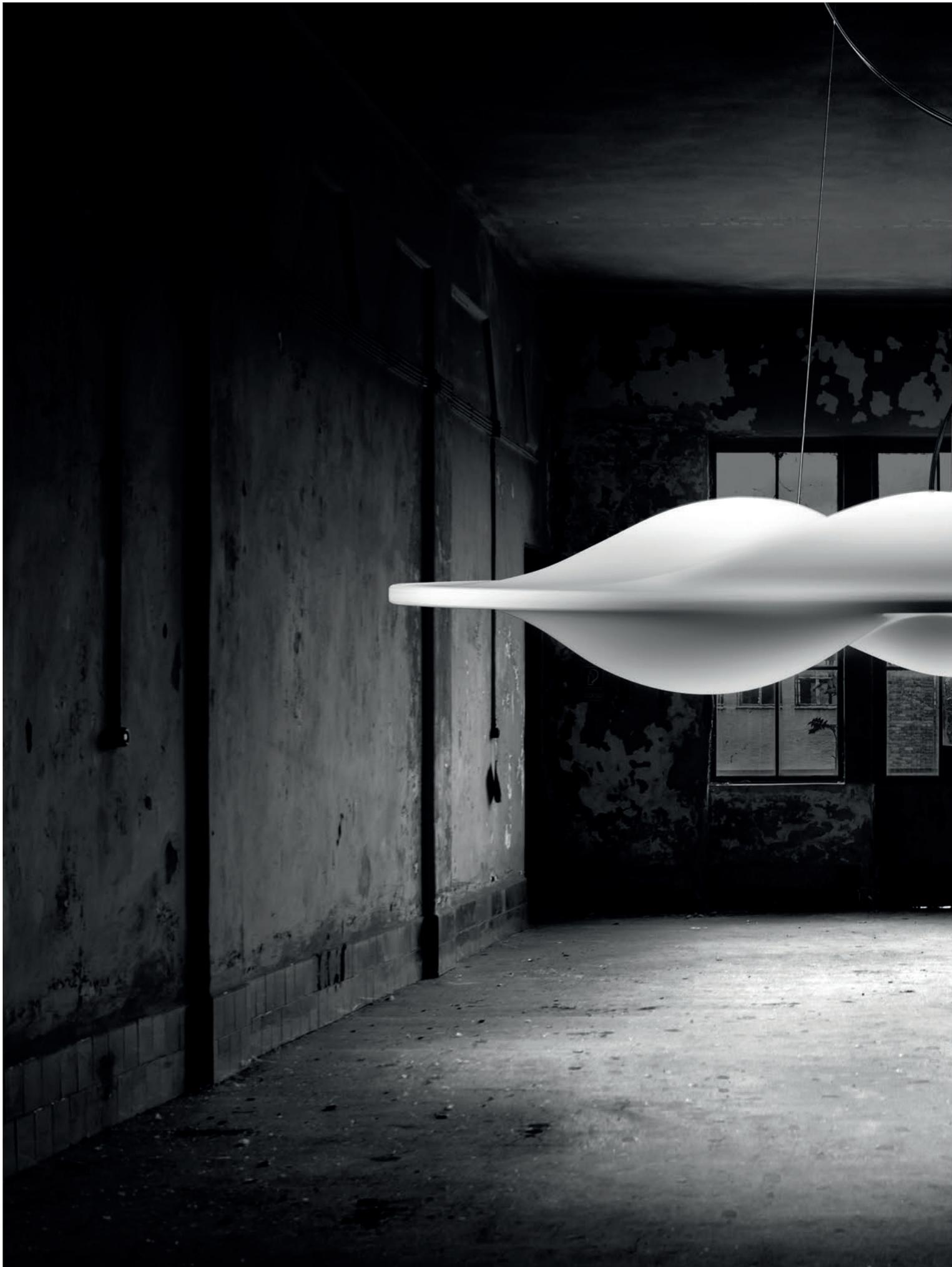

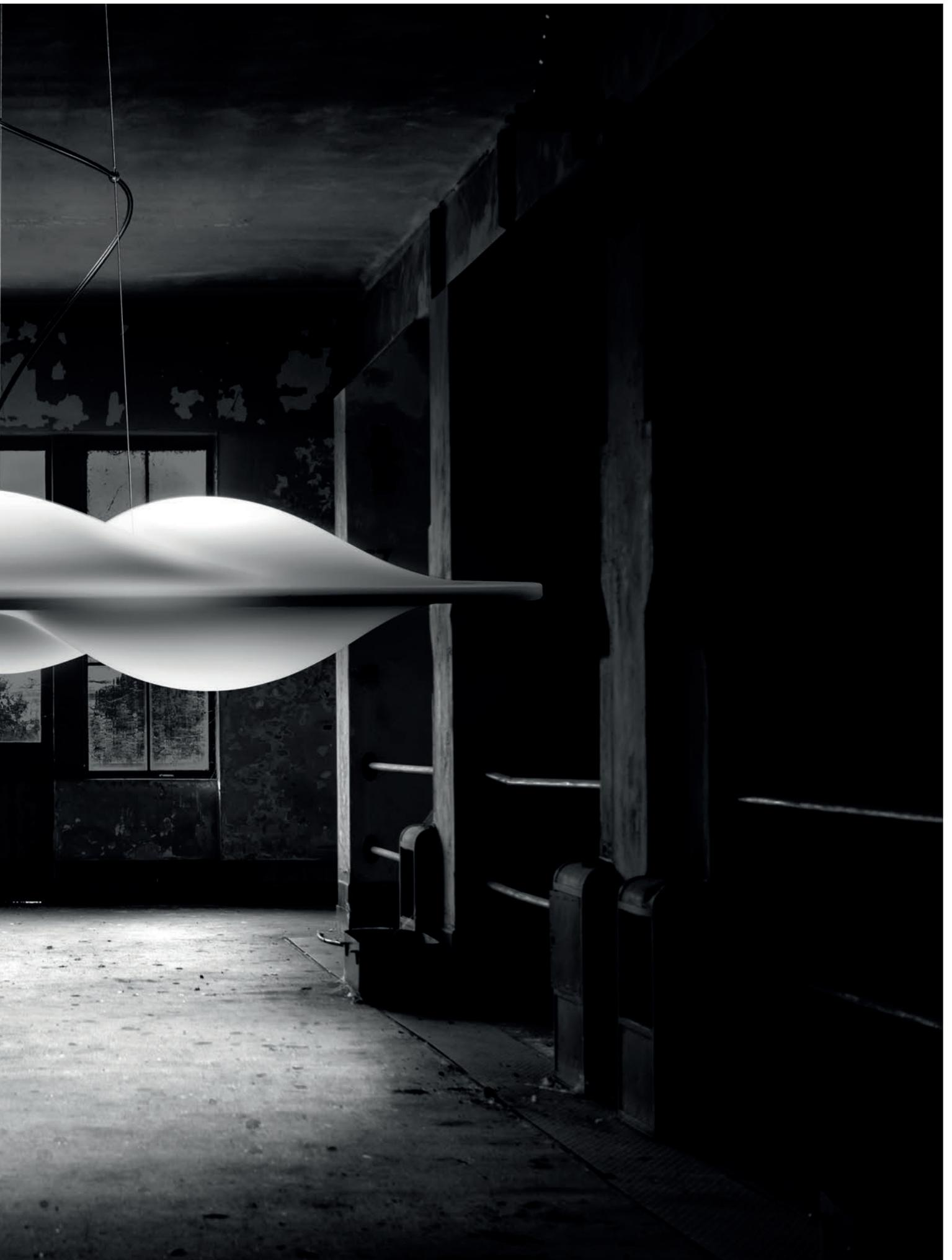





# Technical Info

Dimensioni e composizioni  
Sizes and compositions  
Dimensions et compositions  
Abmessungen und Zusammensetzung  
Dimensiones y composiciones  
Размеры и композиции

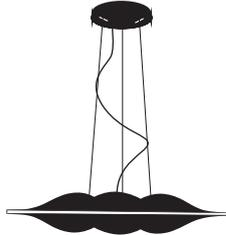

**Circle Wave\_P** | Pendant luminaires | 220-240 V | topLED 28 W

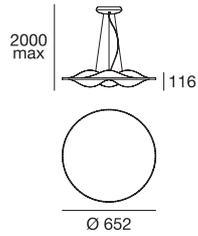

**type**

White CRI 90 **7462**

**colour**

3000 K 3625 lm

**optics**

diffused

**Circle Wave\_P** | Pendant luminaires | 220-240 V | topLED 42 W

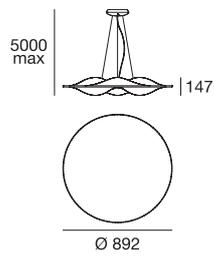

**type**

White CRI 90 **7460**

**colour**

3000 K 5010 lm

**optics**

diffused

**Wave\_S** | Ceiling luminaires | 220-240 V | topLED 28 W

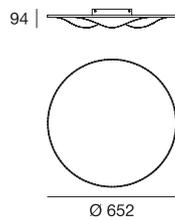

**type**

White CRI 90 **7463**

**colour**

3000 K 3306 lm

**optics**

diffused

**Circle Wave\_S** | Ceiling luminaires | 220-240 V | topLED 42 W

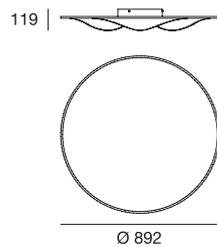

**type**

White CRI 90 **7461**

**colour**

3000 K 4959 lm

**optics**

diffused

# 1Night — 2Nights

IT — Luce eclettica dalla tecnologia versatile. Cilindro in alluminio con diffusore in polycarbonato trasparente, ruotabile e orientabile. Corpo in alluminio pressofuso, semincassato nella versione 1Night. 2Nights permette di proiettare a parete caleidoscopici giochi di luce.

FR — Lumière éclectique à la technologie versatile. Cylindre en aluminium avec diffuseur en polycarbonate transparent, rotatif et orientable. Corps en aluminium moulé sous pression, semi-encastré dans la version 1Night. 2Nights permet de projeter sur le mur des jeux kaléidoscopiques de lumière.

ES — Una luz ecléctica, fruto de la tecnología versátil. Cilindro de aluminio con difusor de polycarbonato transparente, rotativo y orientable. Cuerpo de aluminio moldeado a presión, semiempotrado en la versión 1Night. 2Nights permite proyectar en las paredes juegos de luz calidoscópicos.

EN — Eclectic light with versatile technology. An aluminum cylinder with a transparent, turning and adjustable polycarbonate diffuser. Die-cast aluminium casing, semi-recessed in the 1Night version. 2Nights can project kaleidoscopic lighting games on the wall.

DE — Eklektisches Licht mit vielseitiger Technologie. Ein Aluminiumzylinder mit transparentem, drehbarem und schwenkbarem Diffusor aus Polycarbonat. Das Gehäuse ist aus Aluminiumpressteile und in der Version 1Night als Halbeinbauleuchte ausgeführt. 2Nights erlaubt das projizieren kaleidoskopartige Lichtspiele an die Wand.

PY — Эклектичный светильник с универсальной технологией. Алюминиевый цилиндр с вращающимся и поворотным рассеивателем из прозрачного поликарбоната. Корпус из литого под давлением алюминия, полувстроенный в варианте 1Night. 2Nights проецирует на стену калейдоскопические световые эффекты.

design **Davide Oppizzi**, 2016-2018



reddot award 2016  
winner









2Nights wall light









2Nights pendant luminaires





## Technical Info

Dimensioni e composizioni  
Sizes and compositions  
Dimensions et compositions  
Abmessungen und Zusammensetzung  
Dimensiones y composiciones  
Размеры и композиции



**1Night** | Semi-recessed light | 220-240 V | powerLED 4 W | integrated ON/OFF switch

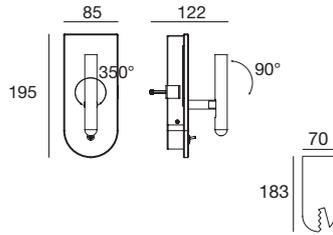

**type**

Wh.	Wh.	CRI 90	<b>8636</b>
Bl.	Bl.	CRI 90	<b>8637</b>
Wh.	R.G.	CRI 90	<b>8639</b>
Bl.	Go.	CRI 90	<b>8638</b>

**colour**

3000 K 363 lm

**optics**

70°

Installabile su cartongesso e superfici in legno.  
 It can be installed on drywall or wood surfaces.  
 Peut être installé sur placoplâtre et des surfaces en bois.  
 Kann auf Gipskarton und Oberflächen aus Holz installiert werden.  
 Instalable en cartón yeso y en superficies de madera.  
 Для установки на гипсокартоне и деревянных поверхностях.

**2Nights\_W1** | Wall light | 220-240 V | powerLED 4 W

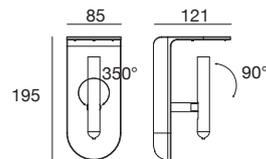

**type**

Wh.	Wh.	CRI 90	<b>7975</b>
Bl.	Bl.	CRI 90	<b>7977</b>
Wh.	R.G.	CRI 90	<b>7942</b>
Bl.	Go.	CRI 90	<b>7944</b>

**colour**

3000 K 363 lm

**optics**

70°

**accessories**



**included**  
filters

**KITS**  
gobo filters

**2Nights\_W2** | Wall light | 220-240 V | powerLED 4 W | integrated ON/OFF switch

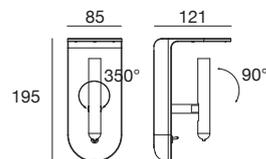

**type**

Wh.	Wh.	CRI 90	<b>7976</b>
Bl.	Bl.	CRI 90	<b>7978</b>
Wh.	R.G.	CRI 90	<b>7943</b>
Bl.	Go.	CRI 90	<b>7945</b>

**colour**

3000 K 363 lm

**optics**

70°

**accessories**



**included**  
filters

**KITS**  
gobo filters

2Nights | gobo filter Fire



type

White	KIT0035
Black	KIT0036



2Nights | gobo filter Tree



type

White	KIT0055
Black	KIT0056



2Nights | gobo filter Water



type

White	KIT0057
Black	KIT0058

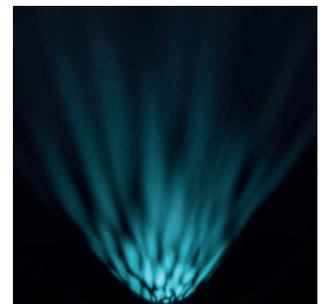

2Nights | coloured, transparent and opal filters



type

Amber	included
Opaque	included
Transp.	included

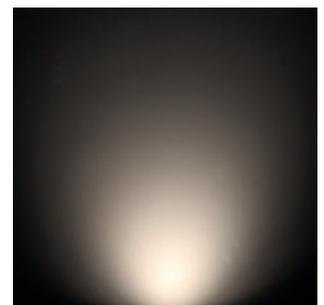



2Nights\_P3 | Pendant luminaires | 220-240 V | powerLED 7 W

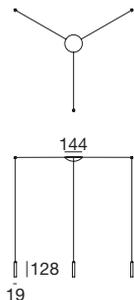

Lunghezza cavo 3 m.  
 Cable lenght 3 m.  
 Longueur de câble 3 m.  
 Kabellänge 3 m.  
 Largo del cable 3 m.  
 Длина кабеля 3 м.

type

Wh.	Wh.	CRI 90	<b>8640</b>
Bl.	Bl.	CRI 90	<b>8641</b>
Wh.	R.G.	CRI 90	<b>8642</b>
Bl.	Go.	CRI 90	<b>8643</b>

colour

3000 K 762 lm

optics

70°

2Nights\_P6 | Pendant luminaires | 220-240 V | powerLED 14 W

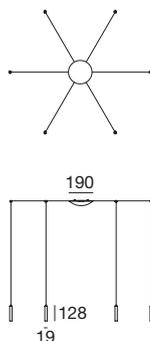
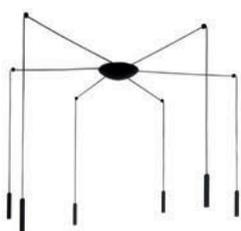

Lunghezza cavo 3 m.  
 Cable lenght 3 m.  
 Longueur de câble 3 m.  
 Kabellänge 3 m.  
 Largo del cable 3 m.  
 Длина кабеля 3 м.

type

Wh.	Wh.	CRI 90	<b>8644</b>
Bl.	Bl.	CRI 90	<b>8645</b>
Wh.	R.G.	CRI 90	<b>8646</b>
Bl.	Go.	CRI 90	<b>8647</b>

colour

3000 K 1524 lm

optics

70°

# Lama

IT — Sintesi tra tecnologia e minimalismo. Forma e doppia emissione della luce smussano contrasti e ombre marcate. Corpo in alluminio con diffusore in policarbonato opalino, è disponibile in diverse applicazioni, anche nella versione piantana da ufficio per l'impiego in ambienti con videotermini.

FR — Synthèse de la technologie et du minimalisme. Sa forme et la double émission de la lumière adoucissent les contrastes et les ombres marquées. Corps en aluminium avec diffuseur en polycarbonate opalin, elle est disponible dans différentes applications, même dans la version lampe de bureau pour une utilisation dans des espaces avec ordinateurs.

ES — Síntesis entre tecnología y minimalismo. La forma y la emisión doble de la luz suavizan contrastes y sombras marcadas. Cuerpo de aluminio con difusor de policarbonato opalino, disponible en distintas aplicaciones, también en la versión lámpara de pie de oficina para el uso en ambientes con terminales de vídeo.

EN — Synthesis between technology and minimalism. Its shape and double light emission smooth contrasts and marked shadows. Aluminum casing with opal polycarbonate diffuser, it is available in different versions, including the Office floor version, perfect for lighting spaces with computers.

DE — Synthese aus Technologie und Minimalismus. Die Form und die doppelte Lichtabstrahlung mildern Kontraste und deutliche Schatten. Mit Gehäuse aus Aluminium und Diffusor aus opalem Polycarbonat, erhältlich in verschiedenen Versionen, auch als Stehleuchte für Büros, die sich für die Verwendung in Arbeitsumfeldern mit Computerbildschirmen eignet.

PY — Синтез технологии и минимализма. Форма и двойное излучение света сглаживают контрасты и четко выраженные тени. Алюминиевый корпус с рассеивателем из опалового поликарбоната находит разнообразное применение, в том числе в варианте офисного торшера, который можно использовать в помещении с видеотерминалами.

design **Mirco Crosatto**,  
linealightgroup R&D dept., 2011-2018



red dot award 2011  
winner



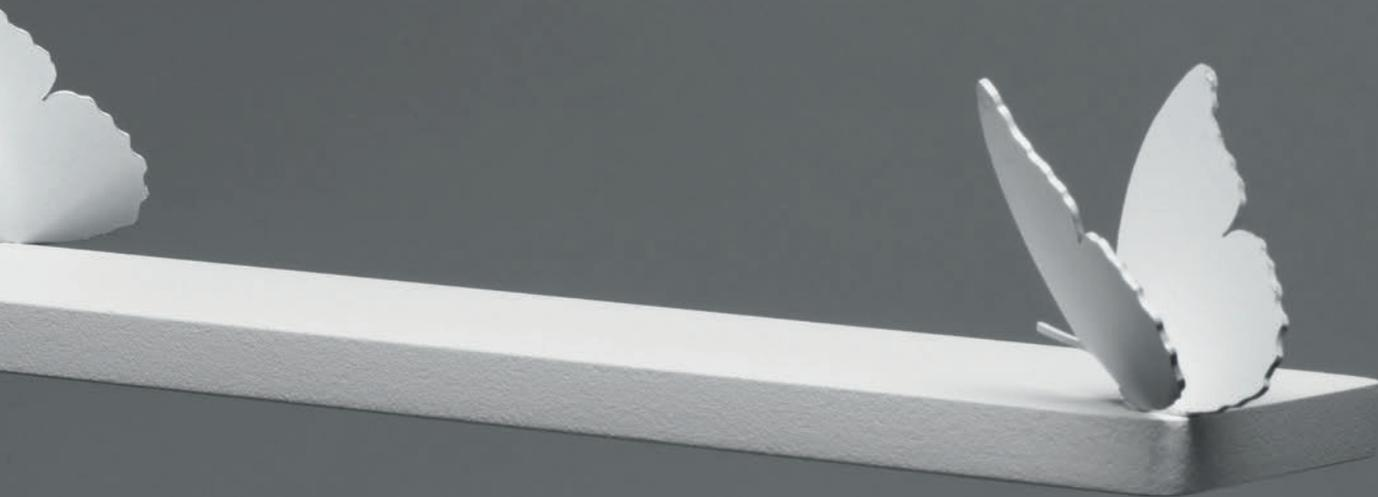



Lama ceiling luminaires







Lama table lamp





Lama office free standing light

## **Technical Info**

Dimensioni e composizioni  
Sizes and compositions  
Dimensions et compositions  
Abmessungen und Zusammensetzung  
Dimensiones y composiciones  
Размеры и композиции



Lama\_P1 | Pendant luminaires | 220-240 V | topLED 45 W

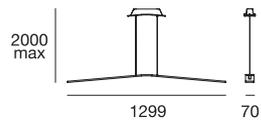

**type**

White	CRI 90	<b>7106</b>
Black	CRI 90	<b>7138</b>

**colour**

3000 K 3241 lm

**optics**

diffused

Lama\_P2 | Pendant luminaires | 220-240 V | topLED 48 W

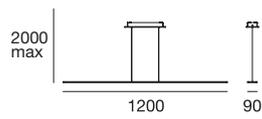

**type**

White	CRI 90	<b>7118</b>
Black	CRI 90	<b>7139</b>

**colour**

3000 K 3450 lm

**optics**

diffused

Lama  
pendant luminaires



Lama\_S | Ceiling luminaires | 220-240 V | topLED 45 W

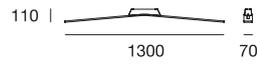

**type**

White	CRI 90	<b>7109</b>
Black	CRI 90	<b>7110</b>

**colour**

3000 K 3241 lm

**optics**

diffused

Lama\_W | Wall light | 220-240 V | topLED 21 W

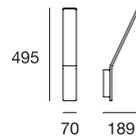

**type**

White	CRI 90	<b>7104</b>
Black	CRI 90	<b>7137</b>

**colour**

3000 K 2505 lm

**optics**

diffused

Lama  
wall light



Lama\_FL | Free standing light | 220-240 V | topLED 26 W

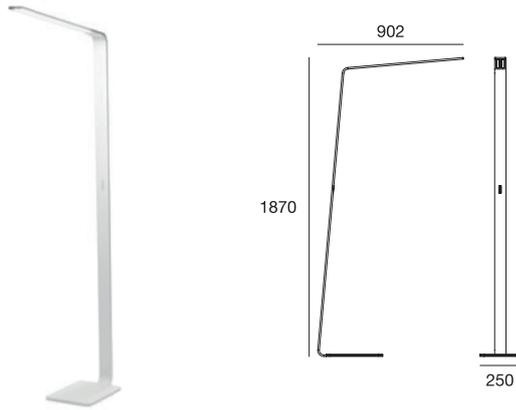

**type**

White	CRI 90	<b>7100</b>
Black	CRI 90	<b>7101</b>

**colour**

3000 K 1870 lm

**optics**

diffused

touch

Lama\_FL office | Free standing light | 220-240 V | topLED 38 W

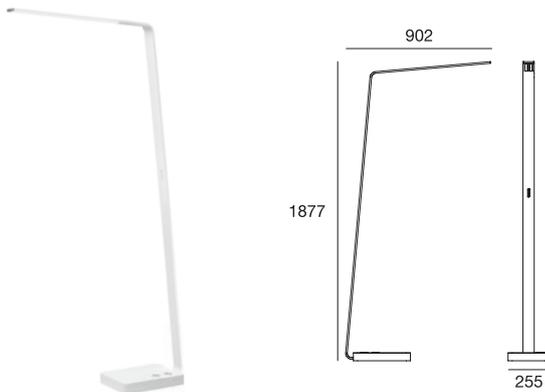

**type**

White	CRI 90	<b>7116</b>
Black	CRI 90	<b>7136</b>

**colour**

3000 K 2760 lm

**optics**

diffused

touch

Lama\_Tab | Table Lamp | 220-240 V | topLED 9 W



**type**

White	CRI 90	<b>7112</b>
Black	CRI 90	<b>7113</b>

**colour**

3000 K 624 lm

**optics**

diffused

touch

# Saturn

<sup>IT</sup> — Anelli luminosi liberamente sospesi. La lampada, concepita per l'illuminazione di ampi spazi retail o ambienti pubblici, ha il corpo illuminante in polietilene bianco e sorgente LED dimmerabile.

<sup>FR</sup> — Des anneaux lumineux librement suspendus. La lampe, conçue pour l'éclairage de grands magasins et d'espaces publics, possède un corps lumineux en polyéthylène blanc et une source LED variable.

<sup>ES</sup> — Anillos luminosos suspendidos libremente. La lámpara, concebida para la iluminación de amplios espacios en tiendas al por menor o en ambientes públicos, presenta un cuerpo de iluminación de polietileno blanco y una fuente LED regulable en intensidad.

<sup>EN</sup> — Lighting rings freely suspended. A suspension created to light large retail or public areas. It has a white polyethylene casing and dimming LED source.

<sup>DE</sup> — Frei schwebende Lichtringe. Die Leuchte, die für die Beleuchtung großer Räume in Geschäften oder an öffentlichen Orten konzipiert wurde, hat einen Leuchtenkörper aus weißem Polyethylen und eine dimmbare LED Lichtquelle.

<sup>PY</sup> — Свободно подвешенные светящиеся кольца. Лампа, предназначенная для освещения больших залов розничной торговли или общественных мест, имеет световой корпус из белого полиэтилена и светодиодный источник с регулируемой яркостью.

design **linealight**group R&D dept., 2014-2016









Saturn ceiling luminaires







Saturn pendant luminaires



Saturn wall light

# Technical Info

Dimensioni e composizioni  
Sizes and compositions  
Dimensions et compositions  
Abmessungen und Zusammensetzung  
Dimensiones y composiciones  
Размеры и композиции

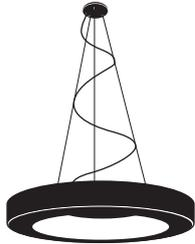

Saturn\_P | Pendant luminaires | 220-240 V | topLED 33 W

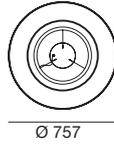

type

White	CRI 90	<b>7652</b>
White	CRI 90	<b>7652N</b>

colour

3000 K	4229 lm
4000 K	4410 lm

optics

diffused

accessories



**KIT0079**

**CASAMBI**  
DALI Dimmer  
1 art.



Saturn\_P | Pendant luminaires | 220-240 V | topLED 98 W

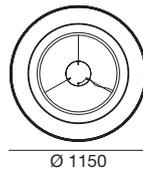
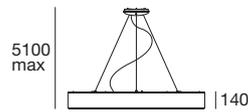

type

White	CRI 90	<b>7650</b>
White	CRI 90	<b>7650N</b>

colour

3000 K	13961 lm
4000 K	14566 lm

optics

diffused

accessories



**KIT0079**

**CASAMBI**  
DALI Dimmer  
1 art.



Saturn\_S | Ceiling luminaires | 220-240 V | topLED 33 W



179 | | 100

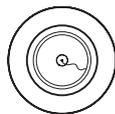

Ø 757



type

White	CRI 90	<b>7653</b>
White	CRI 90	<b>7653N</b>

colour

3000 K	4229 lm
4000 K	4410 lm

optics

diffused

accessories



**KIT0079**

**CASAMBI**  
DALI Dimmer  
1 art.



Saturn\_S | Ceiling luminaires | 220-240 V | topLED 98 W



213 | | 140

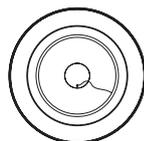

Ø 1150



type

White	CRI 90	<b>7651</b>
White	CRI 90	<b>7651N</b>

colour

3000 K	13961 lm
4000 K	14566 lm

optics

diffused

accessories



**KIT0079**

**CASAMBI**  
DALI Dimmer  
1 art.





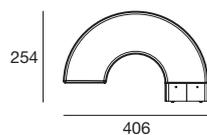

**type**

White CRI 90 7654

**colour**

3000 K 1480 lm

**optics**

diffused

# Kyklos

<sup>IT</sup> — Un corpo orbitante alto solo due centimetri. Kyklos\_P1 è un anello in poliuretano espanso, bianco o nella nuova finitura bronzo, a emissione indiretta. Kyklos\_P2 ha un secondo anello superiore riflettente, capace di trasformare la lampada in sorgente a doppia emissione.

<sup>FR</sup> — Un corps orbital haut de seulement deux centimètres. Kyklos\_P1 est un anneau en polyuréthane expansé blanc ou dans la nouvelle finition bronze, à émission indirecte. Kyklos\_P2 présente un second anneau supérieur réfléchissant, capable de transformer la lampe en source à double émission.

<sup>ES</sup> — Un cuerpo orbitante de dos centímetros solamente de altura. Kyklos\_P1 es un anillo de poliuretano expandido, blanco o en el nuevo acabado de bronce, con emisión indirecta. Kyklos\_P2 presenta un segundo anillo superior reflectante, que transforma la lámpara en una fuente de emisión doble.

<sup>EN</sup> — Orbiting casing two centimeters thick. Kyklos\_P1 is a polyurethane ring with indirect light emission, available in white or in the new bronze finish. Kyklos\_P2 with a second upper ring, transforming the luminaire in doubled emission.

<sup>DE</sup> — Ein nur zwei Zentimeter großer Himmelskörper im Orbit. Kyklos\_P1 ist ein Ring aus PU-Hartschaum in Weiß oder mit der neuen Oberfläche in Bronze und indirekter Lichtabstrahlung. Kyklos\_P2 verfügt über einen zweiten, reflektieren Ring, der Leuchte in eine zweiflammige Lichtquelle verwandelt.

<sup>PY</sup> — Вращающийся корпус высотой всего два сантиметра. Kyklos\_P1 – это кольцо из белого пенополиуретана или с новой бронзовой отделкой с отраженным излучением. Kyklos\_P2 имеет второе верхнее отражающее кольцо, которое способно превратить светильник в источник двойного излучения.

design **linealight**group R&D dept., 2014-2018



**red dot** award 2015  
winner







Kyklos pendant luminaires

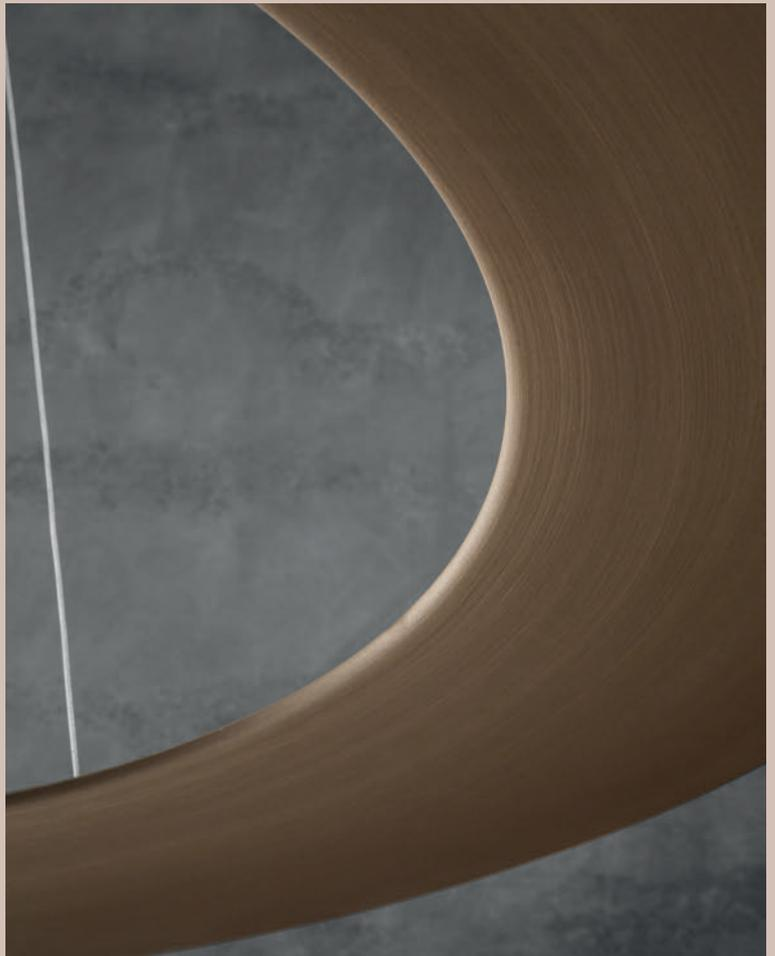









# Technical Info

Dimensioni e composizioni  
Sizes and compositions  
Dimensions et compositions  
Abmessungen und Zusammensetzung  
Dimensiones y composiciones  
Размеры и композиции



Kyklos\_P1 | Pendant luminaires | 220-240 V | topLED 42 W

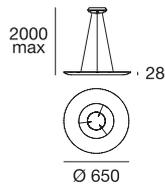

type

White	CRI 90	<b>8485</b>
Bronze	CRI 90	<b>8487</b>

colour

3000 K 4173 lm

optics

diffused

accessories



**KIT0080**  
**CASAMBI**  
 Phase-Cut Dimmer  
 1 art.



**KIT0026**  
 Phase-Cut Dimmer  
 1-2 art.



Kyklos\_P1 | Pendant luminaires | 220-240 V | topLED 55 W

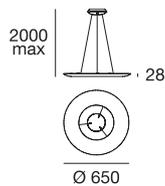

type

White	CRI 90	<b>7981</b>
Bronze	CRI 90	<b>8481</b>

colour

3000 K 5564 lm

optics

diffused

accessories



**KIT0079**  
**CASAMBI**  
 DALI Dimmer  
 1 art.



Kyklos\_P1 | Pendant luminaires | 220-240 V | topLED 91 W

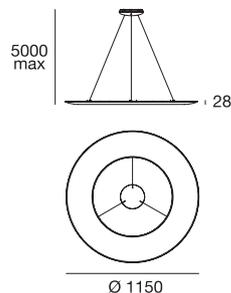

type

White	CRI 90	<b>7982</b>
Bronze	CRI 90	<b>8483</b>

colour

3000 K 9160 lm

optics

diffused

accessories



**KIT0079**  
**CASAMBI**  
 DALI Dimmer  
 1 art.



Kyklos\_P2 | Pendant luminaires | 220-240 V | topLED 42 W

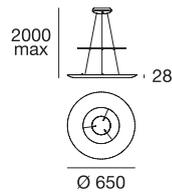

type

White	CRI 90	<b>8486</b>
Bronze	CRI 90	<b>8488</b>

colour

3000 K 4173 lm

optics

diffused

accessories



**KIT0080**  
**CASAMBI**  
 Phase-Cut Dimmer  
 1 art.



**KIT0026**  
 Phase-Cut Dimmer  
 1-2 art.



Kyklos\_P2 | Pendant luminaires | 220-240 V | topLED 55 W

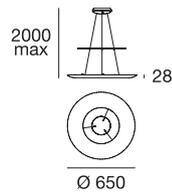

type

White	CRI 90	<b>7984</b>
Bronze	CRI 90	<b>8482</b>

colour

3000 K 5564 lm

optics

diffused

accessories



**KIT0079**  
**CASAMBI**  
 DALI Dimmer  
 1 art.



Kyklos\_P2 | Pendant luminaires | 220-240 V | topLED 91 W

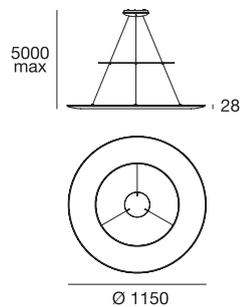

type

White	CRI 90	<b>7985</b>
Bronze	CRI 90	<b>8484</b>

colour

3000 K 9180 lm

optics

diffused

accessories



**KIT0079**  
**CASAMBI**  
 DALI Dimmer  
 1 art.



Kyklos\_W | Wall Light | 220-240 V | topLED 19 W



type

White	CRI 90	<b>7740</b>
Bronze	CRI 90	<b>7758</b>

colour

3000 K 1500 lm

optics

diffused

accessories



**KIT0080**  
**CASAMBI**  
Phase-Cut Dimmer  
1-2 art.



**KIT0026**  
Phase-Cut Dimmer  
1-5 art.



Kyklos\_W | Wall Light | 220-240 V | topLED 38 W

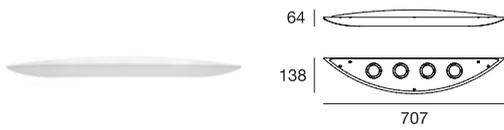

type

White	CRI 90	<b>7741</b>
Bronze	CRI 90	<b>7759</b>

colour

3000 K 3000 lm

optics

diffused

accessories



**KIT0080**  
**CASAMBI**  
Phase-Cut Dimmer  
1 art.



**KIT0026**  
Phase-Cut Dimmer  
1-2 art.



# Reflexio

<sup>IT</sup> — Innovazione invisibile all'occhio, nascosta, per questo ancora più bella. La luce viene diffusa dal riflettore a cupola e si espande in tutto l'ambiente. L'abbagliamento diretto è totalmente assente. Interamente in metallo, è disponibile nelle varianti cromatiche bianco e nero.

<sup>FR</sup> — Une innovation invisible à l'œil nu, cachée, et donc encore plus belle. La lumière est diffusée par le réflecteur en coupole et s'étend à tout l'espace. L'éblouissement direct est totalement absent. Entièrement en métal, elle est disponible en blanc et en noir.

<sup>ES</sup> — Innovación invisible para el ojo, oculta, más bella todavía por eso. La luz es difundida por el reflector en cúpula y se expande por todo el ambiente. El deslumbramiento directo desaparece totalmente. Totalmente de metal, existe en las variantes cromáticas de los colores blanco y negro.

<sup>EN</sup> — Innovation that is invisible to the eye, hidden, and therefore even more beautiful. The light is diffused by the dome reflector and spreads throughout the environment. Direct glare is totally absent. Made entirely of metal, available in white and black.

<sup>DE</sup> — Eine für das Auge nicht sichtbare, verborgene Innovation, die deshalb umso schöner ist. Das Licht wird von einem kuppelförmigen Reflektor abgestrahlt und verbreitet sich im ganzen Raum. Die Beleuchtung ist absolut blendfrei. Mit Innenseite aus Metall, erhältlich in den Farben Weiß und Schwarz.

<sup>PY</sup> — Невидимая глазу, но от этого еще более прекрасная инновация. Свет рассеивается купольным отражателем и распространяется по всему помещению. Прямой слепящий эффект полностью отсутствует. Светильник полностью изготовлен из металла и предлагается в варианте белого или черного света.

design **Mirco Crosatto**,  
linealightgroup R&D dept., 2018













Reflexio ceiling luminaires



Reflexio wall light

## **Technical Info**

Dimensioni e composizioni  
Sizes and compositions  
Dimensions et compositions  
Abmessungen und Zusammensetzung  
Dimensiones y composiciones  
Размеры и композиции



**Reflexio** | Ceiling-Wall light | 220-240 V | topLED 30 W

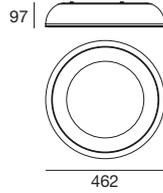

**type**

Wh.	Wh.	CRI 90	<b>8530</b>
Bl.	Wh.	CRI 90	<b>8531</b>

**colour**

3000 K 4042 lm

**optics**

diffused

**accessories**



**KIT0080**  
**CASAMBI**  
Phase-Cut Dimmer  
1 art.



**KIT0026**  
Phase-Cut Dimmer  
1-3 art.



**Reflexio** | Ceiling-Wall light | 220-240 V | topLED 42 W

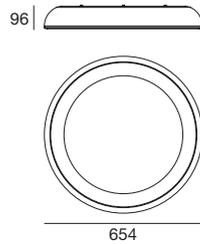

**type**

Wh.	Wh.	CRI 90	<b>8532</b>
Bl.	Wh.	CRI 90	<b>8533</b>

**colour**

3000 K 5671 lm

**optics**

diffused

**accessories**



**KIT0080**  
**CASAMBI**  
Phase-Cut Dimmer  
1 art.



**KIT0026**  
Phase-Cut Dimmer  
1-2 art.



# Oblix

<sup>IT</sup> — Elemento dalla forma volutamente imperfetta e dinamica, dalle linee arrotondate e dal profilo asimmetrico, in contrasto con ambienti rigorosi. In polietilene bianco, è dotato di attacco magnetico altamente performante, solidale con la base in alluminio.

<sup>FR</sup> — Élément à la forme volontairement imparfaite et dynamique, avec des lignes arrondies et un profil asymétrique, en contraste avec des espaces au style rigoureux. En polyéthylène blanc, elle est équipée d'une attache magnétique très performante, solidaire avec la base en aluminium.

<sup>ES</sup> — Elemento con una forma deliberadamente imperfecta y dinámica, con líneas redondeadas y un perfil asimétrico, en contraste con ambientes rigurosos. De polietileno blanco, presenta un enganche magnético de altas prestaciones, fijado en la base de aluminio.

<sup>EN</sup> — This luminaire has been deliberately designed with a dynamic and quite imperfect shaped object, contrasting with rigorous architecture. In white polyethylene, it is integrated with the aluminum base with a very performative magnetic clamp.

<sup>DE</sup> — Elemente mit gewollt unvollkommener und dynamischer Form, abgerundeten Linien und einem asymmetrischen Profil, das einen Kontrast zur strengen Umgebung bildet. Aus weißem Polyethylen mit leistungsstarkem Magnethalter, der fest mit dem Fuß aus Aluminium verbunden ist.

<sup>PY</sup> — Элемент с нарочито несовершенной и динамичной формой с закругленными линиями и асимметричным профилем, контрастирующим со строгой обстановкой. Светильник, изготовленный из белого полиэтилена, имеет очень функциональное магнитное крепление, представляющее одно целое с алюминиевой основой.

design **Pio & Tito Toso**, 2016

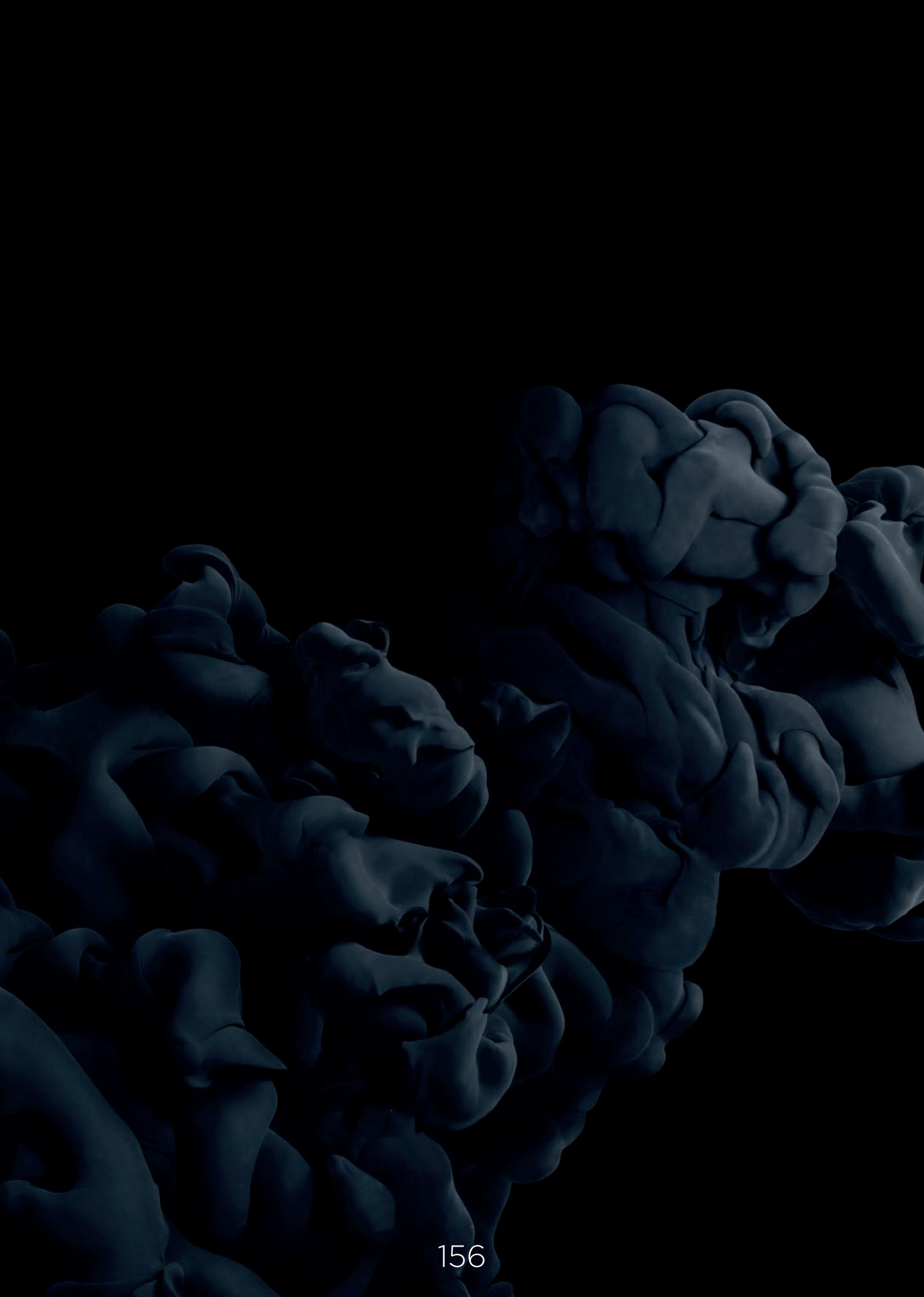









Oblix ceiling luminaires



## Technical Info

Dimensioni e composizioni  
Sizes and compositions  
Dimensions et compositions  
Abmessungen und Zusammensetzung  
Dimensiones y composiciones  
Размеры и композиции

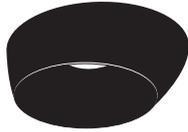

Oblix | Ceiling-Wall light | 220-240 V | topLED 24 W

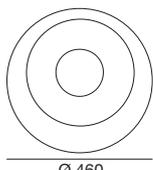

type

White CRI 90 **8181**

colour

2784 K 2784 lm

optics

diffused

accessories



**KIT0080**  
**CASAMBI**  
Phase-Cut Dimmer  
1-2 art.



**KIT0026**  
Phase-Cut Dimmer  
1-4 art.



Oblix | Ceiling-Wall light | 220-240 V | topLED 49 W

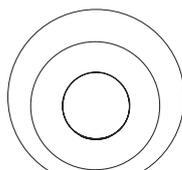
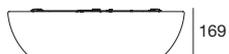

type

White CRI 90 **8182**

colour

3000 K 5510 lm

optics

diffused

accessories



**KIT0080**  
**CASAMBI**  
Phase-Cut Dimmer  
1 art.



**KIT0026**  
Phase-Cut Dimmer  
1-2 art.



# Square

<sup>IT</sup> — Materia tattile su forme semplici, rigorose oppure organiche. Il diffusore in polietilene trova allocazione in un corpo in legno verniciato bianco o in finitura cemento, per un effetto di porosità in linea con le tendenze contemporanee, volte al materico.

<sup>FR</sup> — Une matière tactile sur des formes simples, rigoureuses ou organiques. Le diffuseur en polyéthylène trouve place dans un corps en bois verni blanc ou en finition ciment, pour un effet de porosité en ligne avec les tendances contemporaines qui se concentrent sur la matière.

<sup>ES</sup> — Materia táctil en formas sencillas, rigurosas u orgánicas. El difusor de polietileno se aloja en un cuerpo de madera pintado de color blanco o con acabado de cemento, para obtener un efecto de porosidad en sintonía con las tendencias contemporáneas, enfocadas a lo matérico.

<sup>EN</sup> — Tactile material over neat, clear and organic shapes. Polyethylene diffuser is housed in a white painted wood casing, available also in a concrete finish, for a porous effect following the contemporary trends.

<sup>DE</sup> — Fühlbare Struktur in besonderen Formen, die streng und gleichzeitig organisch sind. Der Diffusor aus Polyethylen ist an einem Gehäuse aus Holz mit Lackierung in Weiß oder mit Oberfläche in Zement angebracht, für einen porösen Effekt, ganz auf einer Linie mit den materischen Oberflächen, die im Trend liegen.

<sup>PY</sup> — Тактильный материал на простых строгих или природных формах. Рассеиватель из полиэтилена размещается в деревянном корпусе, выкрашенном в белый цвет или в корпусе с цементной отделкой, создающей эффект пористости в духе последних тенденций, отдающих дань фактурности.

design **linealight**group R&D dept., 2014



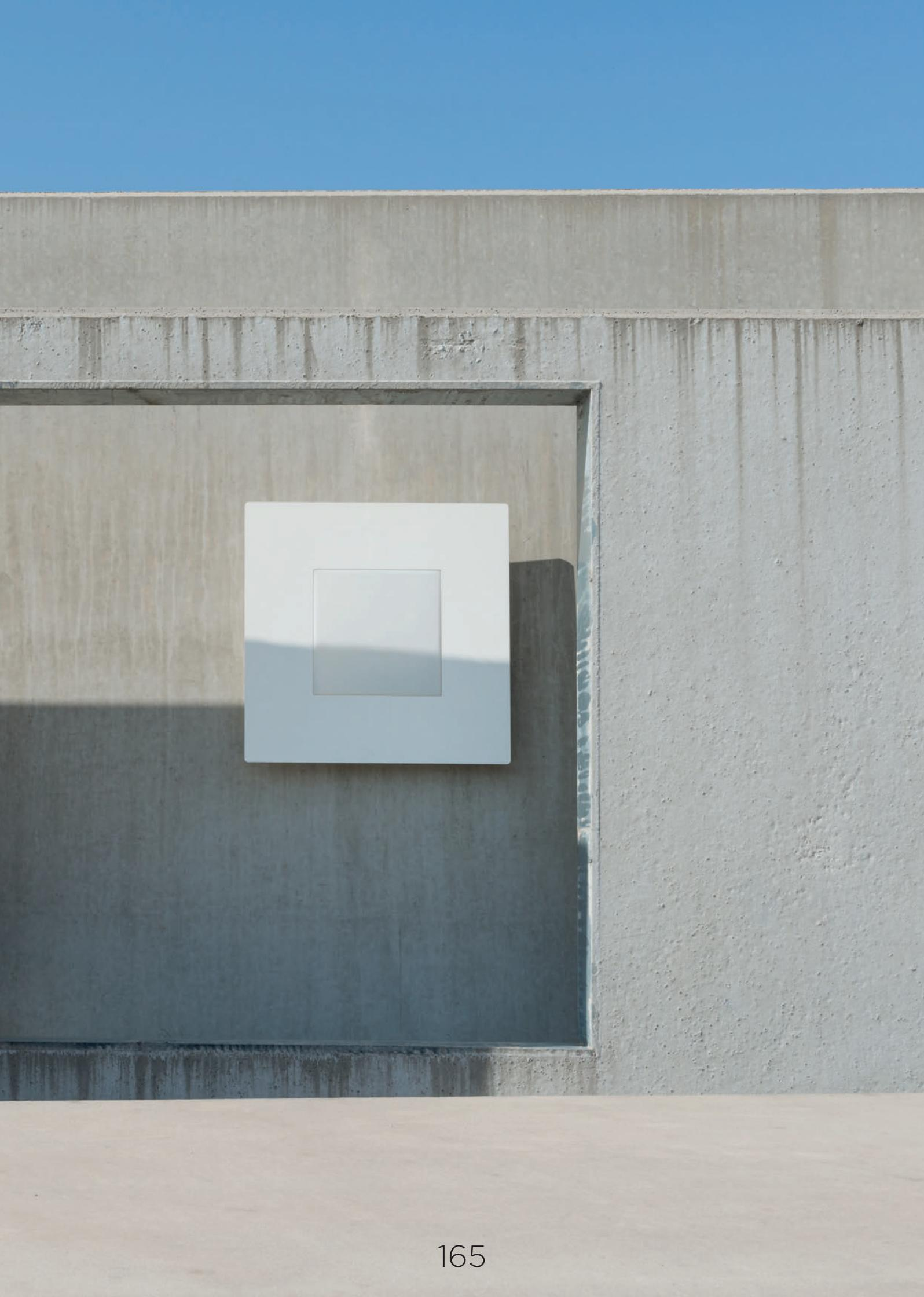





**Square** pendant luminaires





Square pendant luminaires





# Technical Info

Dimensioni e composizioni  
Sizes and compositions  
Dimensions et compositions  
Abmessungen und Zusammensetzung  
Dimensiones y composiciones  
Размеры и композиции



Square\_PQ | Pendant luminaires | 220-240 V | topLED 28 W

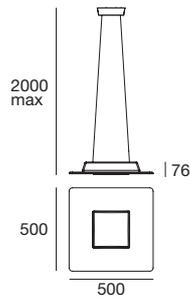

type

White	CRI 90	<b>8122</b>
Concrete	CRI 90	<b>8123</b>

colour

3000 K 3062 lm

optics

diffused

accessories



**KIT0080**  
**CASAMBI**  
Phase-Cut Dimmer  
1 art.



**KIT0026**  
Phase-Cut Dimmer  
1-3 art.



Square\_PQ | Pendant luminaires | 220-240 V | topLED 37 W

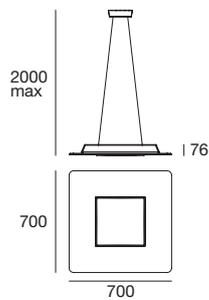

type

White	CRI 90	<b>8126</b>
Concrete	CRI 90	<b>8127</b>

colour

3000 K 4132 lm

optics

diffused

accessories



**KIT0080**  
**CASAMBI**  
Phase-Cut Dimmer  
1 art.



**KIT0026**  
Phase-Cut Dimmer  
1-2 art.



Square\_PB | Pendant luminaires | 220-240 V | topLED 39 W

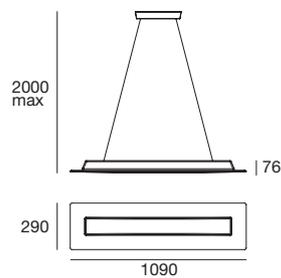

type

White	CRI 90	<b>8510</b>
Concrete	CRI 90	<b>8511</b>

colour

3000 K 5158 lm

optics

diffused

accessories



**KIT0080**  
**CASAMBI**  
Phase-Cut Dimmer  
1 art.



**KIT0026**  
Phase-Cut Dimmer  
1-2 art.



Square\_SQ | Ceiling\_Wall light | 220-240 V | topLED 28 W

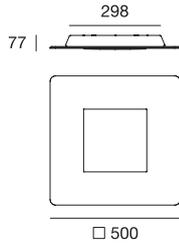

type

White	CRI 90	8120
Concrete	CRI 90	8121

colour

3000 K 3062 lm

optics

diffused

accessories



**KIT0080**  
CASAMBI  
Phase-Cut Dimmer  
1 art.



**KIT0026**  
Phase-Cut Dimmer  
1-3 art.



Square\_SQ | Ceiling luminaires | 220-240 V | topLED 37 W

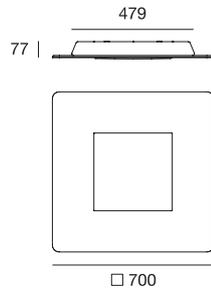

type

White	CRI 90	8124
Concrete	CRI 90	8125

colour

3000 K 4132 lm

optics

diffused

accessories



**KIT0080**  
CASAMBI  
Phase-Cut Dimmer  
1 art.



**KIT0026**  
Phase-Cut Dimmer  
1-2 art.



Square\_SB | Ceiling luminaires | 220-240 V | topLED 39 W

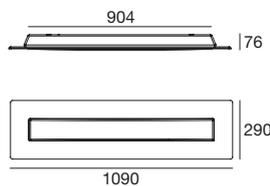

type

White	CRI 90	8128
Concrete	CRI 90	8129

colour

3000 K 5127 lm

optics

diffused

accessories



**KIT0080**  
CASAMBI  
Phase-Cut Dimmer  
1 art.



**KIT0026**  
Phase-Cut Dimmer  
1-2 art.





Square\_PR | Pendant luminaires | 220-240 V | topLED 23 W

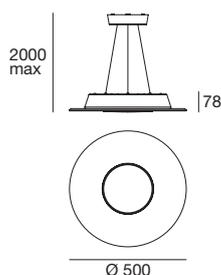

type

White	CRI 90	8514
Concrete	CRI 90	8515

colour

3000 K 2755 lm

optics

diffused

accessories



**KIT0080**  
CASAMBI  
Phase-Cut Dimmer  
1-2 art.



**KIT0026**  
Phase-Cut Dimmer  
1-4 art.



Square\_PR | Pendant luminaires | 220-240 V | topLED 32 W

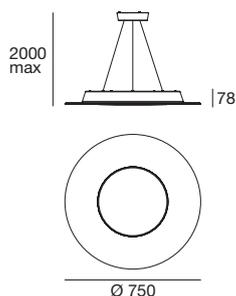

type

White	CRI 90	8518
Concrete	CRI 90	8519

colour

3000 K 4145 lm

optics

diffused

accessories



**KIT0080**  
CASAMBI  
Phase-Cut Dimmer  
1 art.



**KIT0026**  
Phase-Cut Dimmer  
1-3 art.



Square\_SR | Ceiling-Wall light | 220-240 V | topLED 23 W

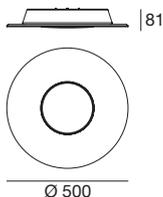

type

White	CRI 90	8512
Concrete	CRI 90	8513

colour

3000 K 2755 lm

optics

diffused

accessories



**KIT0080**  
CASAMBI  
Phase-Cut Dimmer  
1-2 art.



**KIT0026**  
Phase-Cut Dimmer  
1-4 art.



Square\_SR | Ceiling luminaires | 220-240 V | topLED 32 W

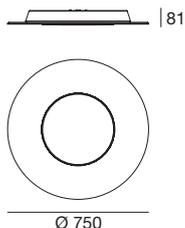

type

White	CRI 90	8516
Concrete	CRI 90	8517

colour

3000 K 4145 lm

optics

diffused

accessories



**KIT0080**  
CASAMBI  
Phase-Cut Dimmer  
1 art.



**KIT0026**  
Phase-Cut Dimmer  
1-3 art.



# Entourage

IT — Una cupola, forma archetipica reinterpretata in ottica contemporanea. Rivestita con nuovi materiali, al polietilene si aggiungono le audaci finiture cemento, cortén e gesso. La tecnologia Warm Tune™ permette di dimmerare l'intensità luminosa variando contemporaneamente la temperatura colore.

FR — Une forme archétypale, la coupole, est réinterprétée dans une perspective contemporaine. Elle est revêtue de nouveaux matériaux : au polyéthylène s'ajoutent les finitions audacieuses ciment, corten et plâtre. La technologie Warm Tune™ permet de varier en même temps l'intensité lumineuse et de la température de couleur.

ES — Una cúpula, una forma arquetípica reinterpretada en una óptica contemporánea. Revestida con nuevos materiales, los atrevidos acabados en cemento, corten y yeso se suman al polietileno. La tecnología Warm Tune™ permite regular la intensidad luminosa al variar al mismo tiempo la temperatura color.

EN — A dome, revisited archetypic shape in contemporary twist. Covered with new finishes, adding to opal polyethylene the concrete, corten and plaster daring finishes. Warm Tune™ technology allows dimmable luminous intensity and color temperature control simultaneously.

DE — Die klassische Form einer Halbkugel in einer modernen Interpretation. Zu den neuen Materialien der Oberfläche kommen neben Polyethylen auch die gewagteren Versionen aus Zement, Corten und Gips. Die Warm Tune™ Technologie erlaubt es, gleichzeitig die Helligkeit und die Farbtemperatur zu ändern.

PY — Архетипная форма купола, интерпретированная в современном ключе. Отделка из новых материалов: наряду с полиэтиленом используется смелая отделка из цемента, кортена и гипса. Технология Warm Tune™ позволяет регулировать яркость света, одновременно изменяя цветовую температуру.

design **linealightgroup** R&D dept., 2009-2016







Entourage pendant luminaires





Traditional light



@ 100%



@ 5%

Relaxing light





## **Technical Info**

Dimensioni e composizioni  
Sizes and compositions  
Dimensions et compositions  
Abmessungen und Zusammensetzung  
Dimensiones y composiciones  
Размеры и композиции

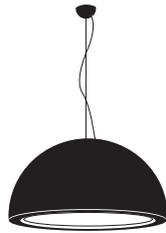

Entourage\_P1 | Pendant luminaires | 220-240 V | arrayLED 16 W

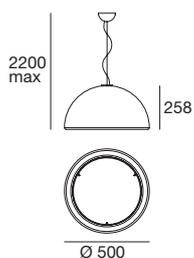

**type**

Concrete	CRI 90	<b>7676</b>
Gypsum	CRI 90	<b>7677</b>
Cor-ten	CRI 90	<b>7678</b>

**colour**

Warm Tune 1000 lm

**optics**

diffused

**accessories**



**KIT0080**  
CASAMBI  
Phase-Cut Dimmer  
1-3 art.



**KIT0026**  
Phase-Cut Dimmer  
1-6 art.



Entourage\_P1 | Pendant luminaires | 220-240 V | arrayLED 28 W

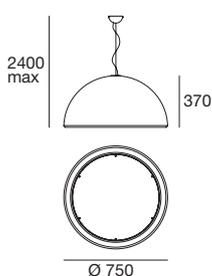

**type**

Concrete	CRI 90	<b>7694</b>
Gypsum	CRI 90	<b>7695</b>
Cor-ten	CRI 90	<b>7696</b>

**colour**

Warm Tune 1790 lm

**optics**

diffused

**accessories**



**KIT0080**  
CASAMBI  
Phase-Cut Dimmer  
1 art.



**KIT0026**  
Phase-Cut Dimmer  
1-3 art.



Entourage\_P1 | Pendant luminaires | 220-240 V | arrayLED 56 W

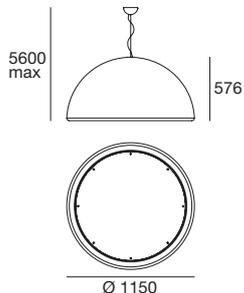

**type**

Concrete	CRI 90	<b>7697</b>
Gypsum	CRI 90	<b>7698</b>
Cor-ten	CRI 90	<b>7699</b>

**colour**

Warm Tune 3580 lm

**optics**

diffused

**accessories**



**KIT0080**  
CASAMBI  
Phase-Cut Dimmer  
1 art.



**KIT0026**  
Phase-Cut Dimmer  
1 art.



Entourage\_P1 | Pendant luminaires | 220-240 V | 2xE27

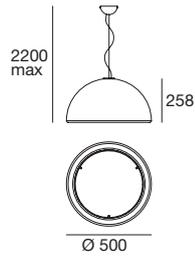

type

Concrete	7663
Gypsum	7664
Cor-ten	7665

source

2x46 W Max

optics

diffused

Entourage\_P1 | Pendant luminaires | 220-240 V | 3xE27

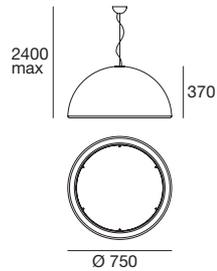

type

Concrete	7666
Gypsum	7667
Cor-ten	7668

source

3x46 W Max

optics

diffused

Entourage\_P1 | Pendant luminaires | 220-240 V | 5xE27

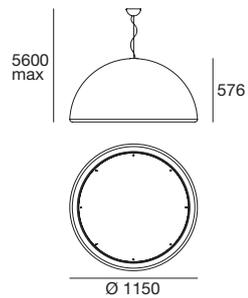

type

Concrete	7669
Gypsum	7670
Cor-ten	7671

source

5x46 W Max

optics

diffused

Entourage\_P2 | Pendant luminaires | 220-240 V | 2xE27

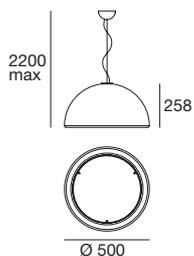

**type**

White **7660**

**source**

2x46 W max

**optics**

diffused

Entourage\_P2 | Pendant luminaires | 3xE27

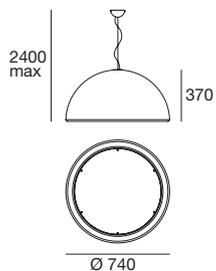

**type**

White **7661**

**source**

3x46 W max

**optics**

diffused

Entourage\_P2 | Pendant luminaires | 5xE27

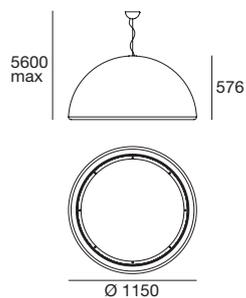

**type**

White **7662**

**source**

5x46 W max

**optics**

diffused

# Opti-Line

<sup>IT</sup> — Evoluzione dell'iconica O-Line, il corpo sospeso è una lastra in PMMA caratterizzato da microincisioni al laser (OptiLight Technology™) che distribuiscono la luce nel piano sottostante. La trama è esteticamente elegante a lampada accesa, mentre a luce spenta scompare nel diffusore completamente trasparente. Montatura in alluminio lucido o verniciato bianco.

<sup>FR</sup> — Évolution du produit emblématique O-Line, le corps suspendu est une plaque en PMMA caractérisé de micro-incisions au laser (OptiLight Technology™) qui distribuent vers le dessous la lumière. La trame est esthétiquement élégante quand la lampe est allumée, tandis qu'elle disparaît dans le diffuseur entièrement transparent quand la lumière est éteinte. Monture en aluminium brillant ou verni blanc.

<sup>ES</sup> — Evolución de la icónica O-Line, el cuerpo suspendido es una plancha de PMMA, caracterizado por micrograbados al láser (OptiLight Technology™), que distribuyen la luz en la superficie inferior. La trama resulta estéticamente elegante con la lámpara encendida mientras que, con la luz apagada, desaparece en el difusor completamente transparente. Estructura de aluminio brillante o pintado de color blanco.

<sup>EN</sup> — Evolution of the iconic O-Line, the new suspended unit is a PMMA plate with a characteristic micro laser-engraved pattern (OptiLight Technology™) that distributes light downwards. The pattern is aesthetically elegant when light is on, becoming completely transparent when light is off. Mounting plate available in white coated or in glossy aluminium finishes.

<sup>DE</sup> — Bei dieser Weiterentwicklung der Ikone O-Line ist der hängende Leuchtenkörper ein Element aus PMMA mit Mikro-Lasergravuren (OptiLight Technology™), die das Licht auf die darunter liegende Fläche abstrahlen. Die Textur zeichnet bei eingeschalteter Leuchte durch ihre ästhetische Eleganz aus und macht den Diffusor bei ausgeschaltetem Licht transparent und praktisch unsichtbar. Mit Fassung aus glänzendem Aluminium oder mit Lackierung in Weiß.

<sup>PY</sup> — Новая версия легендарного O-Line, подвешенный корпус которой представляет собой пластину из ПММА с лазерными микронасечками (технология OptiLight Technology™), которые направляют свет на нижележащую плоскость. Плетение выглядит очень элегантно при включенном светильнике, в то время как при выключенном свете его совершенно не видно, а рассеиватель кажется прозрачным. Рама из блестящего или выкрашенного белой краской алюминия.

design **linealightgroup** R&D dept., 2016









Opti-Line pendant luminaires





## Technical Info

Dimensioni e composizioni  
Sizes and compositions  
Dimensions et compositions  
Abmessungen und Zusammensetzung  
Dimensiones y composiciones  
Размеры и композиции

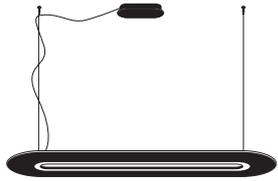

Opti-Line | Pendant luminaires | 220-240 V | topLED 47 W

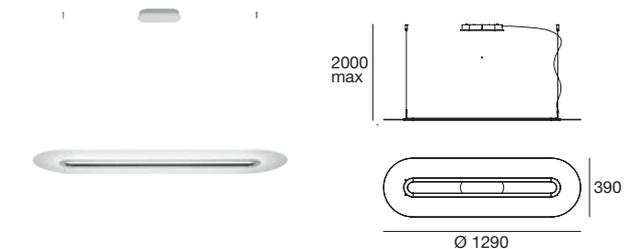

type

White	CRI 90	<b>8037</b>
Polish Al.	CRI 90	<b>8038</b>

colour

3000 K 5685 lm

optics

diffused

accessories



**KIT0079**

**CASAMBI**  
DALI Dimmer  
1 art.



Opti-Line | Pendant luminaires | 220-240 V | topLED 47 W

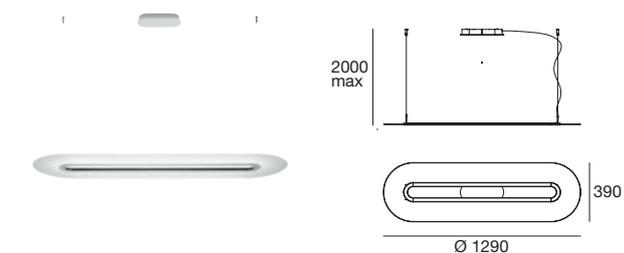

type

White	CRI 90	<b>8490</b>
Polish Al.	CRI 90	<b>8491</b>

colour

3000 K 5685 lm

optics

diffused

accessories



**KIT0080**

**CASAMBI**  
Phase-Cut Dimmer  
1 art.



**KIT0026**

Phase-Cut Dimmer  
1-2 art.

# Mr. Magoo

<sup>IT</sup> — Mr. Magoo, ispirata al cappello dell'omonimo personaggio, è una lampada fantasiosa e versatile. Disponibile in diverse varianti e dimensioni, per ogni tipologia di spazio living. Il corpo in polietilene naturale incorpora una sorgente LED o fluorescente.

<sup>FR</sup> — Mr. Magoo, qui s'inspire du chapeau du personnage du même nom, est une lampe fantaisiste et polyvalente. Disponible dans différentes variantes et dimensions, pour chaque type de salon. Le corps en polyéthylène naturel comprend une source LED ou fluorescente.

<sup>ES</sup> — Mr. Magoo, inspirada en el sombrero del homónimo personaje, es una lámpara fantasiosa y versátil. Disponible en distintas variantes y dimensiones, para todas las tipologías de zonas de estar. El cuerpo de polietileno natural incorpora una fuente LED o fluorescente.

<sup>EN</sup> — Mr. Magoo, inspired by the homonymous character's hat, is a hilarious and versatile luminaire. Available in different versions and sizes, suitable for every kind of living space. The polyethylene unit holds a LED or fluorescent source.

<sup>DE</sup> — Mr. Magoo inspiriert sich am Hut der gleichnamigen Figur und ist eine fantasievolle und vielseitige Leuchte. Erhältlich in verschiedenen Ausführungen und Größen für die unterschiedlichsten Wohnbereiche. Im Leuchtenkörper aus natürlichem Polyethylen ist eine LED Lichtquelle oder eine Leuchtstofflampe installiert.

<sup>PY</sup> — Mr. Magoo, источником вдохновения для которого послужила шляпа одноименного персонажа, – это оригинальный и универсальный светильник. Предлагается в различных вариантах и размерах для любого типа гостиной. В корпусе из натурального полиэтилена располагается светодиодный или люминесцентный источник.

design **Mirco Crosatto**,  
linealightgroup R&D dept., 2010-2016



reddot award 2015  
winner









Mr.Magoo pendant luminaires



Mr.Magoo ceiling luminaires







## Technical Info

Dimensioni e composizioni  
Sizes and compositions  
Dimensions et compositions  
Abmessungen und Zusammensetzung  
Dimensiones y composiciones  
Размеры и композиции

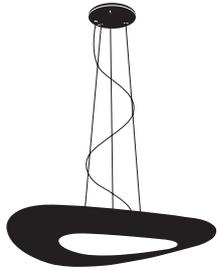

Mr.Magoo\_P | Pendant luminaires | 220-240 V | topLED 23 W

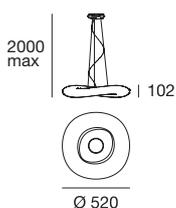

type

White	CRI 90	<b>8005</b>
White	CRI 90	<b>8005N</b>

colour

3000 K	2794 lm
4000 K	2914 lm

optics

diffused

accessories



**KIT0079**

**CASAMBI**  
DALI Dimmer  
1 art.



Mr.Magoo\_P | Pendant luminaires | 220-240 V | topLED 32 W

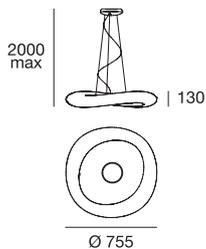

type

White	CRI 90	<b>8007</b>
White	CRI 90	<b>8007N</b>

colour

3000 K	3929 lm
4000 K	4097 lm

optics

diffused

accessories



**KIT0079**

**CASAMBI**  
DALI Dimmer  
1 art.



Mr.Magoo\_P | Pendant luminaires | 220-240 V | topLED 96 W

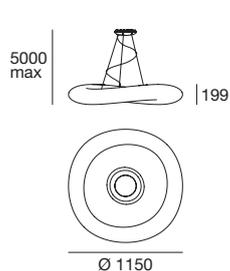

type

White	CRI 90	<b>7788</b>
White	CRI 90	<b>7788N</b>

colour

3000 K	13388 lm
4000 K	13965 lm

optics

diffused

accessories



**KIT0079**

**CASAMBI**  
DALI Dimmer  
1 art.



Mr.Magoo\_P | Pendant luminaires | 220-240 V | topLED 23 W

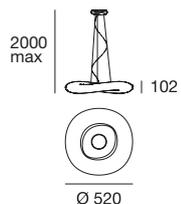

type

White CRI 90 **8135**

colour

3000 K 2794 lm

optics

diffused

accessories



**KIT0080**  
**CASAMBI**  
Phase-Cut Dimmer  
1-2 art.



**KIT0026**  
Phase-Cut Dimmer  
1-4 art.

Mr.Magoo\_P | Pendant luminaires | 220-240 V | topLED 32 W

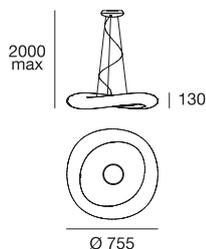

type

White CRI 90 **8137**

colour

3000 K 3929 lm

optics

diffused

accessories



**KIT0080**  
**CASAMBI**  
Phase-Cut Dimmer  
1 art.



**KIT0026**  
Phase-Cut Dimmer  
1-3 art.

Mr.Magoo  
pendant luminaires

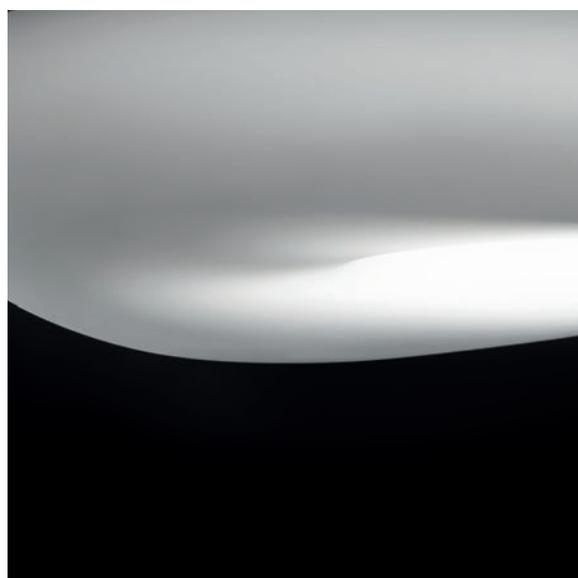



Mr.Magoo\_S | Ceiling luminaires | 220-240 V | topLED 23 W

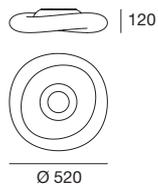

type

White	CRI 90	<b>8006</b>
White	CRI 90	<b>8006N</b>

colour

3000 K	2794 lm
4000 K	2914 lm

optics

diffused

accessories



**KIT0079**

**CASAMBI**  
DALI Dimmer  
1 art.



Mr.Magoo\_S | Ceiling luminaires | 220-240 V | topLED 32 W

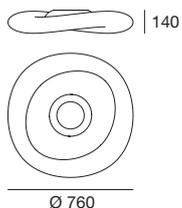

type

White	CRI 90	<b>8008</b>
White	CRI 90	<b>8008N</b>

colour

3000 K	3929 lm
4000 K	4097 lm

optics

diffused

accessories



**KIT0079**

**CASAMBI**  
DALI Dimmer  
1 art.



Mr.Magoo\_S | Ceiling luminaires | 220-240 V | topLED 96 W

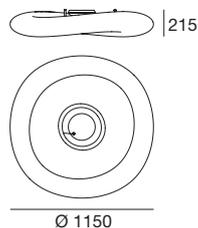

type

White	CRI 90	<b>7789</b>
White	CRI 90	<b>7789N</b>

colour

3000 K	13388 lm
4000 K	13965 lm

optics

diffused

accessories



**KIT0079**

**CASAMBI**  
DALI Dimmer  
1 art.



Mr.Magoo\_S | Ceiling luminaires | 220-240 V | topLED 23 W



 | 120

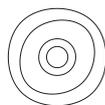

Ø 520



type

White CRI 90 **8136**

colour

3000 K 2794 lm

optics

diffused

accessories



**KIT0080**  
**CASAMBI**  
Phase-Cut Dimmer  
1-2 art.



**KIT0026**  
Phase-Cut Dimmer  
1-4 art.

Mr.Magoo\_S | Ceiling luminaires | 220-240 V | topLED 32 W



 | 140

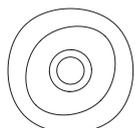

Ø 760



type

White CRI 90 **8138**

colour

3000 K 3929 lm

optics

diffused

accessories



**KIT0080**  
**CASAMBI**  
Phase-Cut Dimmer  
1 art.



**KIT0026**  
Phase-Cut Dimmer  
1-3 art.

Mr.Magoo  
ceiling luminaires



Mr.Magoo\_P | Pendant luminaires | 220-240 V | 1x2GX13

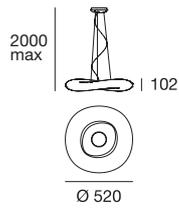

type

White **7790**

source

Fluorescent 1x22 W (included)

optics

diffused

Mr.Magoo\_P | Pendant luminaires | 220-240 V | 1x2GX13

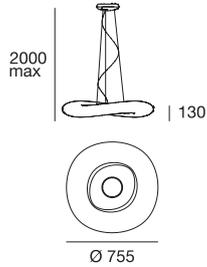

type

White **6860**

source

Fluorescent 1x55 W (included)

optics

diffused

Mr.Magoo\_P | Pendant luminaires | 220-240 V | 4x2G11

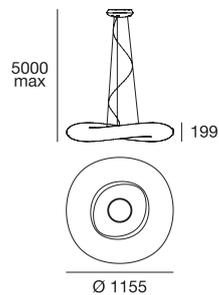

type

White **6858**

source

Fluorescent 4x36 W (included)

optics

diffused

Mr.Magoo\_S | Ceiling luminaires | 220-240 V | 1x2GX13

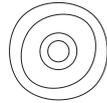

Ø 520

type

White **7792**

source

Fluorescent 1x22 W (included)

optics

diffused

Mr.Magoo\_S | Ceiling luminaires | 220-240 V | 1x2GX13

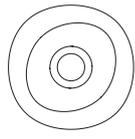

Ø 760

type

White **6857**

source

Fluorescent 1x55 W (included)

optics

diffused

Mr.Magoo\_S | Ceiling luminaires | 220-240 V | 4x2G11

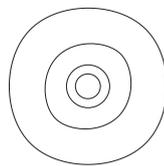

Ø 1155

type

White **7799**

source

Fluorescent 4x36 W (included)

optics

diffused

Mr.Magoo\_FL | Free standing light | 220-240 V | topLED 23 W

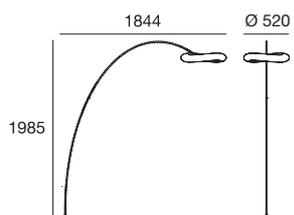

type

White CRI 90 **8009**

colour

3000 K 2794 lm

optics

diffused



# Xilema

<sup>IT</sup> — Perfezione geometrica e tecnologia.  
Corpo in alluminio lucido o con finitura bianca, diffusore in PMMA dotato di ottica WallWasher che “lava” la parete con la sua luce indiretta morbida e soffusa. Le diverse varianti presentano soluzioni estetiche e tecnologiche ricercate.

<sup>FR</sup> — Perfection géométrique et technologie.  
Corps en aluminium brillant ou avec finition blanche, diffuseur en PMMA équipé d'une optique WallWasher qui «lave» le mur avec sa lumière indirecte, douce et diffuse. Les différentes variantes présentent des solutions esthétiques et technologiques recherchées.

<sup>ES</sup> — Perfección geométrica y tecnología.  
Cuerpo de aluminio brillante o con acabado blanco, difusor de PMMA con óptica WallWasher, que “lava” la pared con su luz indirecta suave y teñida. Las distintas variantes presentan soluciones estéticas y tecnológicas refinadas.

<sup>EN</sup> — Geometric and technology perfection.  
Aluminum casing available in white or glossy aluminum versions, equipped with PMMA diffuser with WallWasher optics that “wash” the wall with an indirect smooth and diffusive lighting. Different versions suitable for sophisticated aesthetic and technological solutions.

<sup>DE</sup> — Geometrische und technologische Perfektion. Mit Gehäuse aus glänzendem Aluminium oder mit weißer Oberfläche und Diffusor aus PMMA mit WallWasher Optik, die die Wände mit ihrem weichen und diffusen, indirekten Licht “wäscht”. Die verschiedenen Ausführungen zeichnen sich durch ihr hochwertiges Design und die moderne Technologie aus.

<sup>PY</sup> — Совершенство геометрических форм и высокая технология. Корпус с белой или блестящей алюминиевой отделкой, рассеиватель из ПММА, снабженный оптической системой WallWasher, “омывающей” стены своим мягким приглушенным отраженным светом. Различные варианты представляют изысканный внешний вид и передовые технологии.

design **Edin Dedovic**,  
linealightgroup R&D dept., 2014

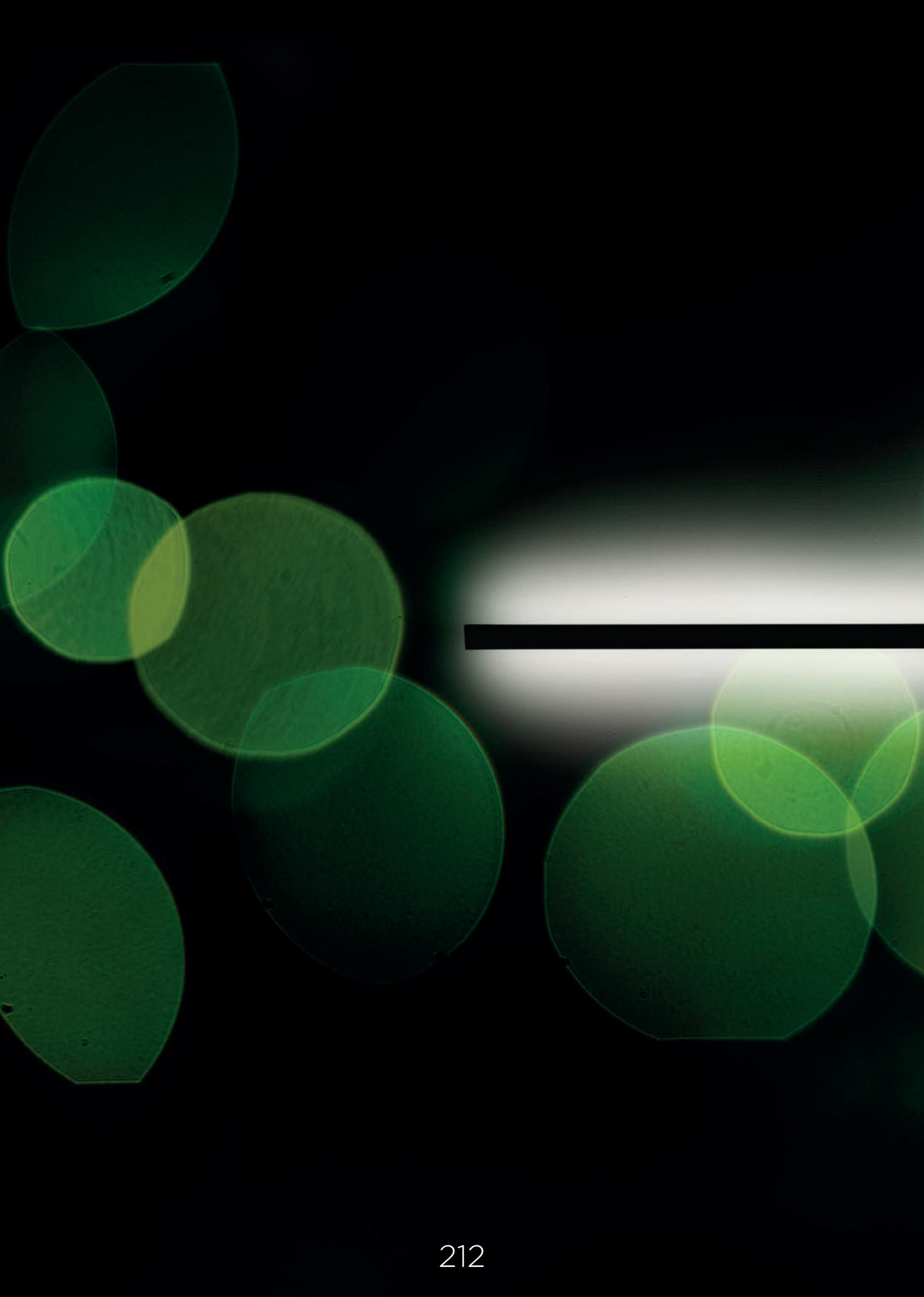

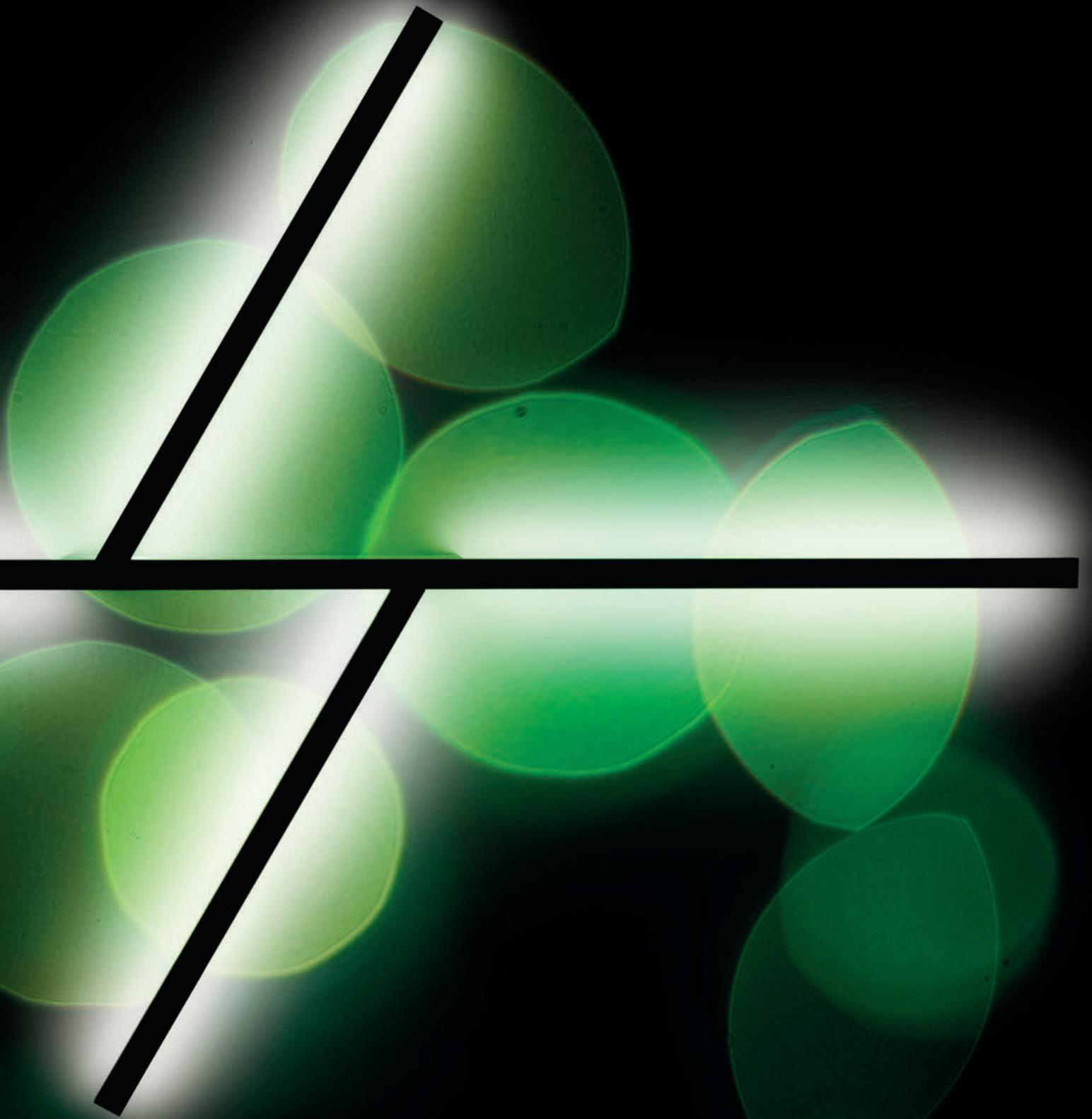





Xilema pendant luminaires









Xilema wall light



Xilema ceiling luminaires



## Technical Info

Dimensioni e composizioni  
Sizes and compositions  
Dimensions et compositions  
Abmessungen und Zusammensetzung  
Dimensiones y composiciones  
Размеры и композиции





Xilema\_P | Pendant luminaires | 220-240 V | topLED 25 W

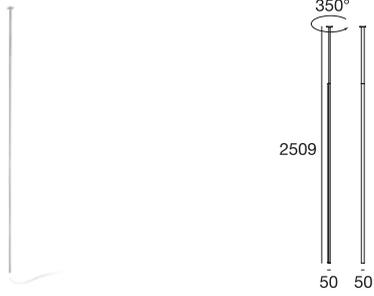

touch

**type**

White	CRI 90	<b>7773</b>
Polish Al.	CRI 90	<b>7774</b>

**colour**

3000 K 2914 lm

**optics**

Asym.

Xilema\_S | Ceiling\_Wall light | 220-240 V | topLED 47 W

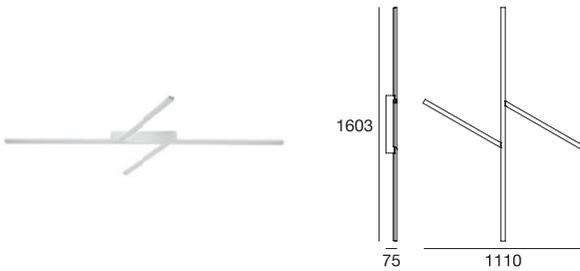

**type**

White	CRI 90	<b>7769</b>
Polish Al.	CRI 90	<b>7770</b>

**colour**

3000 K 6041 lm

**optics**

Asym.

Xilema  
pendant luminaires



Xilema\_W1 | Wall light | 220-240 V | topLED 17 W

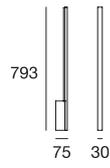

**type**

White CRI 90 **7765**

Polish Al. CRI 90 **7766**

**colour**

3000 K 2100 lm

**optics**

Asym.

Xilema\_W1 | Wall light | 220-240 V | topLED 25 W

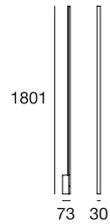

**type**

White CRI 90 **7777**

Polish Al. CRI 90 **7778**

**colour**

3000 K 2914 lm

**optics**

Asym.

touch

Xilema\_WJ | Wall light | 220-240 V | topLED 25 W



**type**

White CRI 90 **7775**

Polish Al. CRI 90 **7776**

**colour**

3000 K 2914 lm

**optics**

Asym.

touch

**Xilema\_W2** | Ceiling-Wall light | 220-240 V | topLED 34 W



**type**

White	CRI 90	<b>7767</b>
Polish Al.	CRI 90	<b>7768</b>

**colour**

3000 K 4200 lm

**optics**

Asym.



**Xilema\_FL** | Free standing light | 220-240 V | topLED 25 W



**type**

White	CRI 90	<b>7771</b>
Polish Al.	CRI 90	<b>7772</b>

**colour**

3000 K 2915 lm

**optics**

Asym.

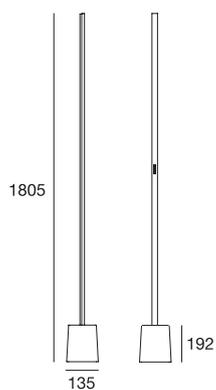

# Kimia

<sup>IT</sup> — Luce fortemente personale. Il piccolo disco illuminante ruota e si muove liberamente lungo l'asta in metallo verniciato bianco o nero. L'illuminazione può variare a piacimento: ambientale, volta ad enfatizzare pareti materiche, oppure diretta a supportare la lettura.

<sup>FR</sup> — Une lumière fortement personnelle. Le petit disque lumineux tourne et se déplace librement le long de la tige en métal verni blanc ou noir. L'éclairage peut varier à l'envie : environnemental, pour souligner la matière des murs, ou direct pour faciliter la lecture.

<sup>ES</sup> — Una luz muy personal. El disco pequeño de iluminación gira y se mueve libremente por la barra de metal pintado de color blanco o negro. La iluminación sigue el gusto personal: ambiental, para enfatizar paredes matéricas, o directa para la lectura.

<sup>EN</sup> — Strongly individual lighting. The small lighting disc rotates and moves freely along the pole in white or black coated metal. Lighting can vary as much as you like: atmospheric, directed to emphasize textural walls, or to assist in reading.

<sup>DE</sup> — Ein Licht mit einer starken Persönlichkeit. Die kleine leuchtende Scheibe lässt sich drehen und frei auf der Stange aus Metall mit Lackierung in Weiß oder Schwarz bewegen. Eine Beleuchtung, die ganz nach Belieben angepasst werden kann, als Umgebungsbeleuchtung, zum Hervorheben von materischen Wänden oder als direktes Licht zum Lesen.

<sup>PY</sup> — Светильник с яркой индивидуальностью. Маленький световой диск вращается и свободно перемещается по стержню из металла, выкрашенному в белый или черный цвет. Вы можете менять освещение в связи с вашими предпочтениями: общее освещение, направленное на подчеркивание фактурных стен, или же прямой свет для чтения.

design **Edin Dedovic**,  
linealightgroup R&D dept., 2018





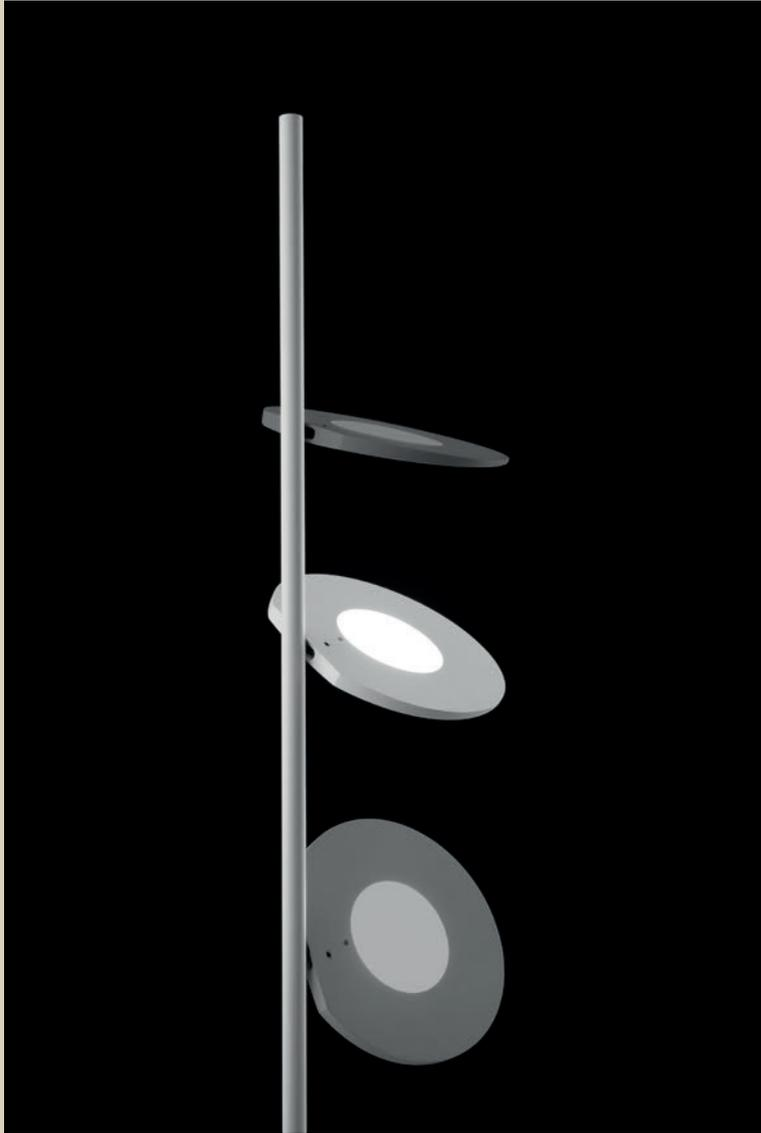

Kimia free standing light







## Technical Info

Dimensioni e composizioni  
Sizes and compositions  
Dimensions et compositions  
Abmessungen und Zusammensetzung  
Dimensiones y composiciones  
Размеры и композиции



Kimia | Free standing light | 220-240 V | topLED 25 W

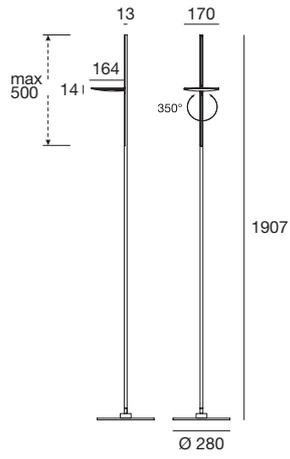

**type**

White	CRI 90	8545
Black	CRI 90	8546

**colour**

3000 K 3000 lm

**optics**

diffused



# Hinomaru

<sup>IT</sup> — Circolare come un sole di impercettibile profondità. Ricercate finiture impreziosiscono il corpo in metallo dallo spessore minimo, solo 2,4 cm. La tecnologia Opti-3 HoneyComb distribuisce la luce grazie ad un diffusore "a tre strati" composto da un recuperatore di flusso, un pannello intermedio in PMMA con microincisioni al laser e un ultimo pannello in PMMA con texture a nido d'ape.

<sup>FR</sup> — Rond comme un soleil d'une imperceptible profondeur. Des finitions raffinées rehaussent le corps en métal d'une épaisseur minimale de seulement 2,4 cm. La technologie Opti-3 HoneyComb distribue la lumière grâce à un diffuseur « à trois épaisseurs » composé d'un récupérateur de flux, d'un panneau intermédiaire en PMMA avec micro-incisions au laser et d'un dernier panneau en PMMA avec une texture en nid d'abeille.

<sup>ES</sup> — Circular como un sol con una profundidad imperceptible. Acabados refinados embellecen el cuerpo de metal con un grosor mínimo, solamente 2,4 cm. La tecnología Opti-3 HoneyComb distribuye la luz mediante un difusor "de tres capas", compuesto por un recuperador de flujo, un panel intermedio de PMMA con micrograbados al láser y un último panel de PMMA con una textura alveolar.

<sup>EN</sup> — Round like a sun of imperceptible depth. Refined finishes embellish the metal casing with a minimum thickness, only 2.4 cm. Opti-3 HoneyComb technology distributes light thanks to a "three-layers" diffuser made up of a flow recuperator, an intermediate PMMA panel with a micro laser-engraved pattern and a last honeycomb PMMA panel.

<sup>DE</sup> — Rund wie eine Sonne ohne wahrnehmbare Tiefe. Hochwertige Oberflächen verschönern das Gehäuse aus Metall mit minimaler Dicke von nur 2,4 cm. Die Opti-3 HoneyComb Technologie strahlt das Licht durch einen "dreischichtigen" Diffusor ab, der aus einem Reflektorblech, einem mittleren Element aus PMMA mit Laser-Mikrogravur und einem weiteren Element aus opalem PMMA besteht mit Wabenstruktur.

<sup>PY</sup> — Круглый как солнце, он обладает неощутимой глубиной. Изысканная отделка украшает металлический корпус толщиной всего 2,4 см. Технология Opti-3 HoneyComb распределяет свет благодаря "трехслойному" рассеивателю, состоящему из рекуператора потолка, промежуточной панели из ПММА с лазерными микронасечками и последней панели из ПММА с сотовой структурой.

design **Mirco Crosatto**,  
**linealight**group R&D dept., 2018





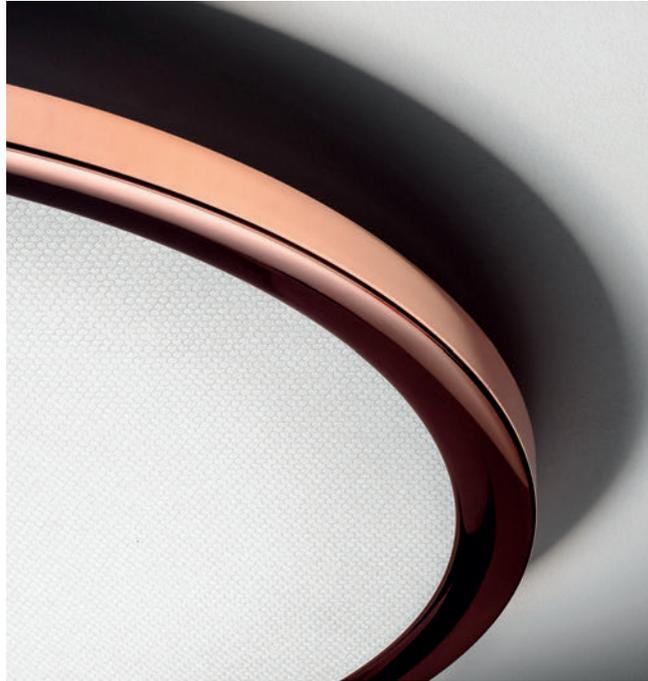

Hinomaru ceiling luminaires







## Technical Info

Dimensioni e composizioni  
Sizes and compositions  
Dimensions et compositions  
Abmessungen und Zusammensetzung  
Dimensiones y composiciones  
Размеры и композиции



Hinomaru\_P | Pendant luminaires | 220-240 V | topLED 30 W

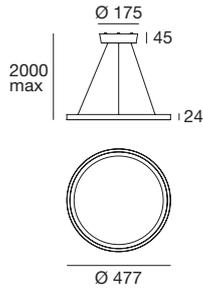

**type**

Bl. Nic.	CRI 90	<b>8614</b>
Rose G.	CRI 90	<b>8615</b>

**colour**

3000 K 4042 lm

**optics**

diffused

**accessories**



**KIT0080**  
CASAMBI  
Phase-Cut Dimmer  
1 art.



**KIT0026**  
Phase-Cut Dimmer  
1-3 art.



Hinomaru\_P | Pendant luminaires | 220-240 V | topLED 42 W

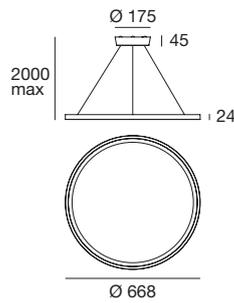

**type**

Bl. Nic.	CRI 90	<b>8618</b>
Rose G.	CRI 90	<b>8619</b>

**colour**

3000 K 5671 lm

**optics**

diffused

**accessories**



**KIT0080**  
CASAMBI  
Phase-Cut Dimmer  
1 art.



**KIT0026**  
Phase-Cut Dimmer  
1-2 art.



Hinomaru\_S | Ceiling-Wall light | 220-240 V | topLED 30 W

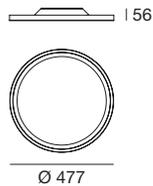

**type**

Bl. Chr.	CRI 90	<b>8606</b>
Rose G.	CRI 90	<b>8607</b>

**colour**

3000 K 4042 lm

**optics**

diffused

**accessories**



**KIT0080**  
CASAMBI  
Phase-Cut Dimmer  
1 art.



**KIT0026**  
Phase-Cut Dimmer  
1-3 art.



Hinomaru\_S | Ceiling luminaires | 220-240 V | topLED 42 W

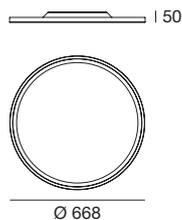

**type**

Bl. Nic.	CRI 90	<b>8610</b>
Rose G.	CRI 90	<b>8611</b>

**colour**

3000 K 5671 lm

**optics**

diffused

**accessories**



**KIT0080**  
CASAMBI  
Phase-Cut Dimmer  
1 art.



**KIT0026**  
Phase-Cut Dimmer  
1-2 art.



# Madame Blanche

<sup>IT</sup> — Due bianchi anelli di alluminio fluttuano paralleli. L'anello inferiore rivolge il fascio luminoso verso il diffusore soprastante, orientabile, dalla avvolgente forma concava, per un'interazione di luce indiretta e omogenea. Una sospensione eclettica, anche nella versione con contrappeso.

<sup>FR</sup> — Deux anneaux blancs de lumière d'aluminium flottent parallèlement. L'anneau inférieur dirige le faisceau lumineux vers le diffuseur orientable, à la forme concave et enveloppante, qui se trouve au-dessus, pour une interaction de lumière indirecte et homogène. Une suspension éclectique, même dans la version avec contrepoids.

<sup>ES</sup> — Dos anillos blancos de aluminio fluctúan paralelamente. El anillo inferior dirige el haz luminoso hacia el difusor superior, orientable, con una forma envolvente cóncava, para lograr una interacción de luz indirecta y homogénea. Una lámpara colgante ecléctica, también en la versión con contrapeso.

<sup>EN</sup> — Two white parallel flying lighting rings. The lower ring directs the light beam toward the upper adjustable diffuser, defined by a wrapped concavity, an interaction between indirect and homogeneous lighting. An eclectic suspension, available also in the version enriched by rings tilting and tensioned by a floor weight.

<sup>DE</sup> — Zwei Ringe aus Licht, die parallel zueinander schweben. Der untere Ring richtet den Lichtstrahl auf den darüber befindlichen, schwenkbaren Diffusor mit konkaver Form, für eine gleichmäßige Beleuchtung mit indirektem Licht. Eine eklektische Hängeleuchte, auch in der Version mit Gegengewicht.

<sup>PY</sup> — Два параллельно парящих кольца света. Нижнее кольцо направляет световой пучок на расположенный выше поворотный рассеиватель вогнутой формы, создавая отраженный однородный свет. Эклектичный подвес, также в варианте с противовесом.

design **Mirco Crosatto**,  
**linealight**group R&D dept., 2016







Madame Blanche pendant luminaires







## **Technical Info**

Dimensioni e composizioni  
Sizes and compositions  
Dimensions et compositions  
Abmessungen und Zusammensetzung  
Dimensiones y composiciones  
Размеры и композиции



Madame Blanche\_P1 | Pendant luminaires | 220-240 V | topLED 32 W

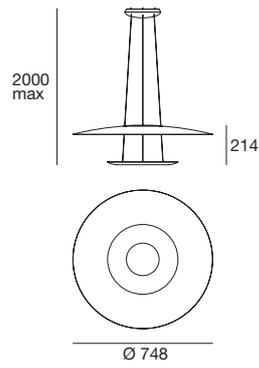

**type**

White CRI 90 **8175**

**colour**

3000 K 3929 lm

**optics**

diffused

**accessories**



**KIT0079**

**CASAMBI**  
DALI Dimmer  
1 art.



Madame Blanche\_P2 | Pendant luminaires | 220-240 V | topLED 32 W

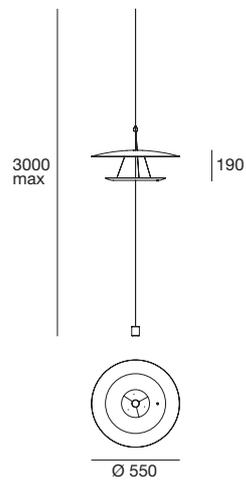

**type**

White CRI 90 **8178**

**colour**

3000 K 3929 lm

**optics**

diffused



# Branch

<sup>IT</sup> — Branch è una fenditura nello spazio, una linea affusolata in alluminio lucido, verniciato bianco oppure nero, evanescente grazie alla doppia emissione. La luce diretta verso il basso è omogenea e precisa, quella indiretta è avvolgente.

<sup>FR</sup> — Branch est une fente dans l'espace, une ligne fuselée en aluminium brillant, verni blanc ou noir, évanescence grâce à sa double émission. La lumière directe vers le bas est homogène et précise, celle indirecte est enveloppante.

<sup>ES</sup> — Branch es una hendidura en el espacio, una línea ahusada de aluminio brillante, pintado de color blanco o negro, evanescente creada por la emisión doble. La luz directa hacia abajo es homogénea y precisa, la indirecta es envolvente.

<sup>EN</sup> — Branch is a space shift, a straight line in glossy aluminum, available in white or black coating. A vanishing bar thanks to its double emission. Direct downward light is homogeneous and precise while indirect one is wrapping.

<sup>DE</sup> — Branch ist ein Riss im Raum, eine schmale, langgezogene Linie aus glänzendem Aluminium mit Lackierung in Weiß oder Schwarz, die durch die zweiflamme Lichtquelle entsteht. Das nach unten gerichtete direkte Licht ist gleichmäßig und präzise, das indirekte Licht komfortabel.

<sup>PY</sup> — Branch – это прорезь в пространстве, тонкая линия из блестящего или выкрашенного белой или черной краской, исчезающая из вида благодаря двойному излучению. Прямой свет, направленный вниз, является однородным и точным, а отраженный свет обволакивающим.

design **Manuel Remeggio**,  
**linealight**group R&D dept., 2012-2018



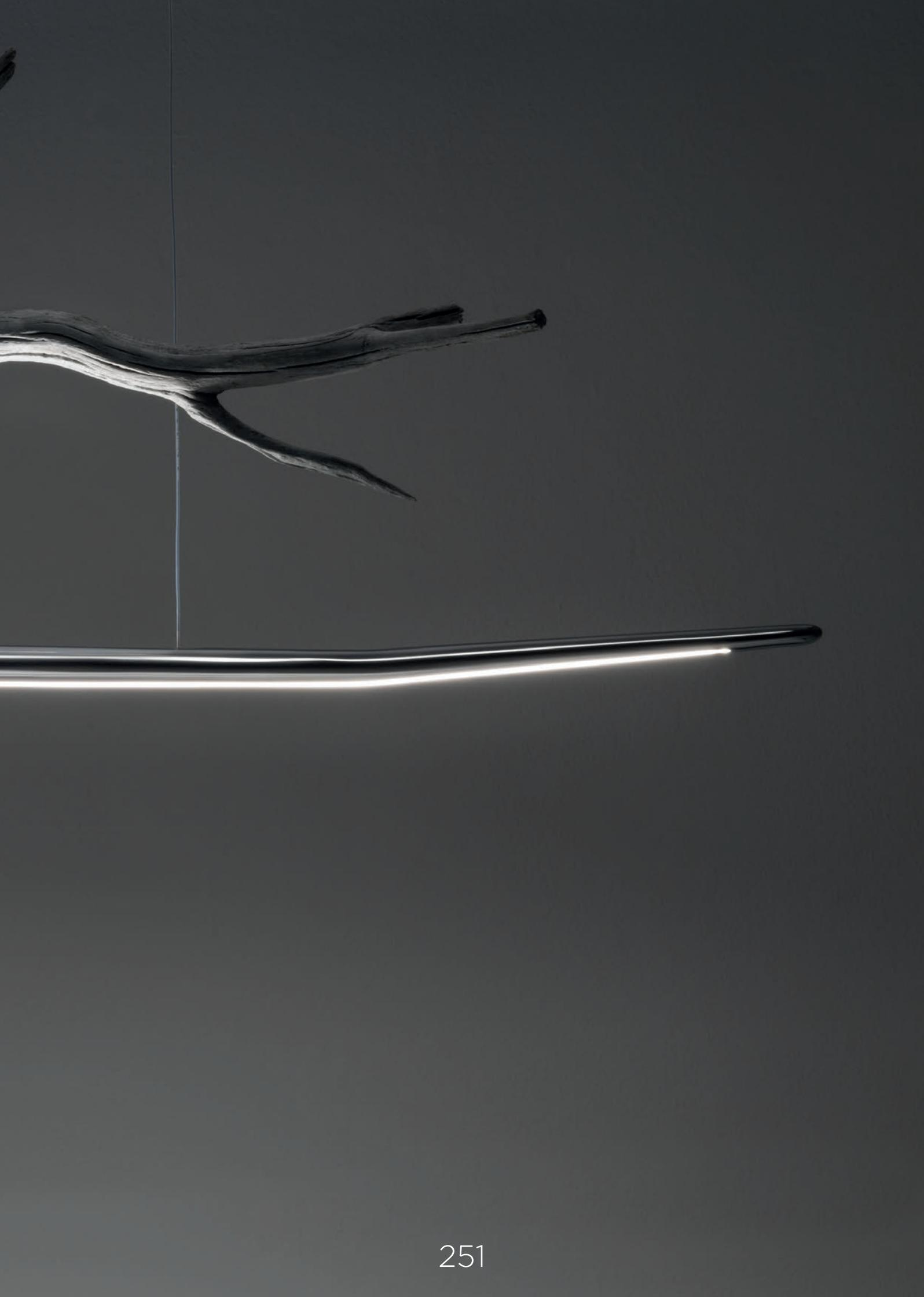



Branch pendant luminaires







## Technical Info

Dimensioni e composizioni  
Sizes and compositions  
Dimensions et compositions  
Abmessungen und Zusammensetzung  
Dimensiones y composiciones  
Размеры и композиции

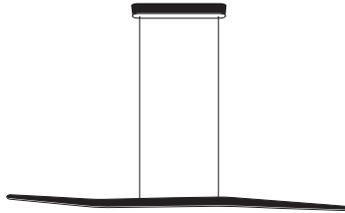

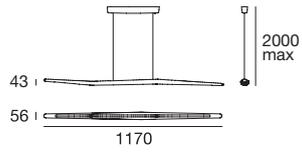

**type**

White	CRI 90	<b>7465</b>
Polish Al.	CRI 90	<b>7466</b>
Black	CRI 90	<b>7467</b>

**colour**

3000 K 2760 lm

**optics**

diffused

# Monarque

<sup>IT</sup> — Forme e materiali antichi per l'abitare contemporaneo. Le lampade a sospensione si enfatizzano l'un l'altra in suggestive applicazioni a grappolo. La finitura in polycarbonato graniglia, dal marcato effetto luccichio, è elegante e raffinata.

<sup>FR</sup> — Des formes et des matériaux anciens pour la maison contemporaine. Les lampes à suspension se mettent en valeur l'une et l'autre dans de suggestives compositions de groupe. La finition en polycarbonate granité, avec effet scintillant marqué, est élégante et raffinée.

<sup>ES</sup> — Formas y materiales antiguos para la vivienda contemporánea. Las lámparas colgantes se enfatizan entre sí en aplicaciones sugerentes en racimo. El acabado en polycarbonato granallado, con un efecto marcado esplendente, es elegante y refinado.

<sup>EN</sup> — Antique shapes and materials for contemporary living. Suspension lights are enhanced in cluster compositions. The granular polycarbonate finish, with a marked glittery effect, is elegant and refined.

<sup>DE</sup> — Antike Formen und Materialien für das moderne Wohnen. Die Hängeleuchten entfalten ihre ganze Schönheit, wenn sie in Clustern aufgehängt werden. Die Oberfläche aus marmoriertem Polycarbonat mit Hochglanzeffekt ist elegant und stylisch.

<sup>PY</sup> — Старинные материалы и формы для современного жилья. Подвесные светильники подчеркивают друг друга в композиции гроздью. Отделка из зернистого поликарбоната с ярко выраженным эффектом сверкания смотрится элегантно и изысканно.

design **linealightgroup** R&D dept., 2016







Monarque pendant luminaires







## Technical Info

Dimensioni e composizioni  
Sizes and compositions  
Dimensions et compositions  
Abmessungen und Zusammensetzung  
Dimensiones y composiciones  
Размеры и композиции



Monarque\_P | Pendant luminaires | 220-240 V | 12 W

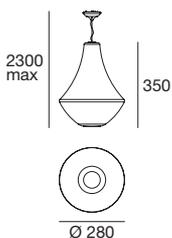

**type**

Granular CRI 90 **8023**

**colour**

3000 K 1511 lm

**optics**

diffused

Monarque\_P | Pendant luminaires | 220-240 V | 38 W

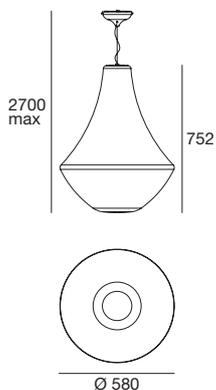

**type**

Granular CRI 90 **8025**

**colour**

3000 K 4701 lm

**optics**

diffused

**accessories**



**KIT0079**  
**CASAMBI**  
DALI Dimmer  
1 art.



## Next

<sup>IT</sup> — Superficie quadrangolare dagli angoli arrotondati, solcata da fenditure di luce precise e rigorose. In materiale termoplastico con diffusore in policarbonato satinato. Le diverse configurazioni consentono di illuminare e arredare con sobria eleganza.

<sup>FR</sup> — Une surface quadrangulaire aux angles arrondis, sillonnée de fentes de lumière précises et rigoureuses. En matériau thermoplastique avec diffuseur en polycarbonate satiné. Les différentes configurations permettent d'éclairer et de décorer avec une sobre élégance.

<sup>ES</sup> — Una superficie cuadrangular con ángulos redondeados, surcada por hendiduras de luz precisas y marcadas. De material termoplástico con difusor de policarbonato satinado. Las varias configuraciones permiten iluminar y decorar con una elegancia sobria.

<sup>EN</sup> — Square rounded surface, engraved by rigorous and precise lighting slits. In thermoplastic material with satin-finished polycarbonate diffuser. The different configurations make it possible to illuminate and decorate with simple elegance.

<sup>DE</sup> — Viereckige Flächen mit abgerundeten Ecken, durchbrochen von strengen und präzisen Lichtschlitzen. Aus Thermoplast mit Diffusor aus satiniertem Polycarbonat. Die verschiedenen Ausführungen garantieren eine Beleuchtung und Einrichtung mit nüchterner Eleganz.

<sup>PY</sup> — Четырехугольная поверхность с закругленными углами раскрывает решительные и строгие световые прорезы. Изготовлен из термопластика с рассеивателем из сатинированного поликарбоната. Различные конфигурации освещают и оформляют помещение, придавая ему строгую элегантность.

design **Mirco Crosatto**,  
**linealight**group R&D dept., 2012



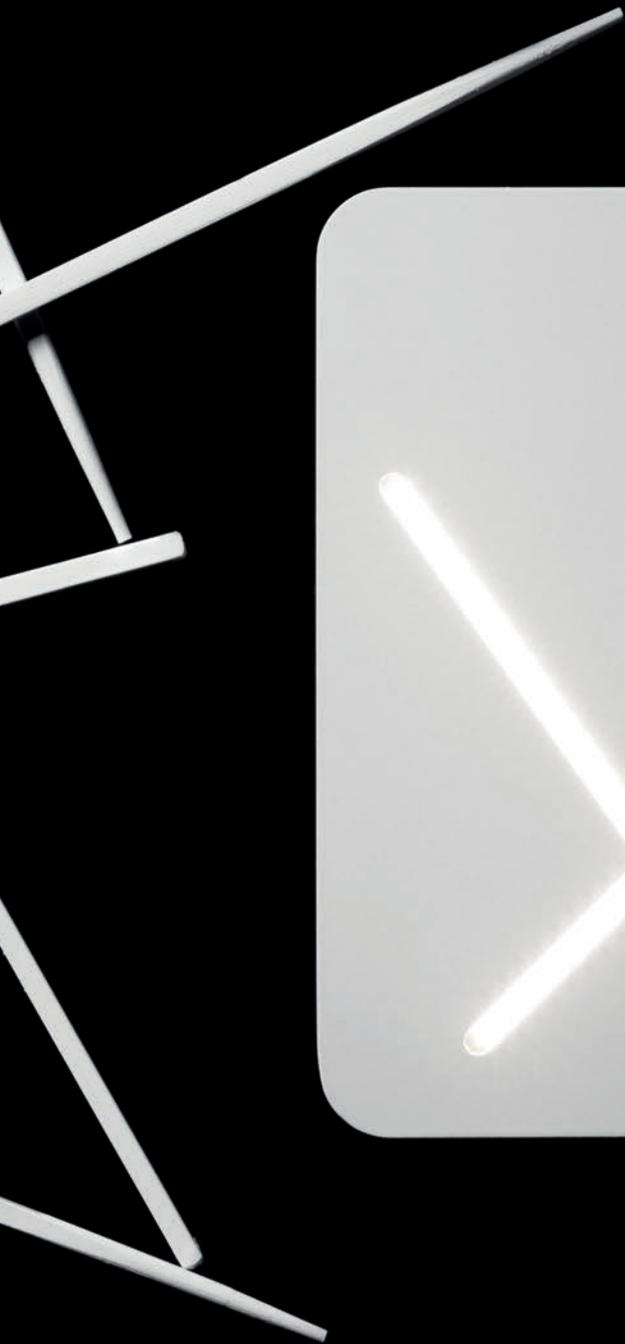

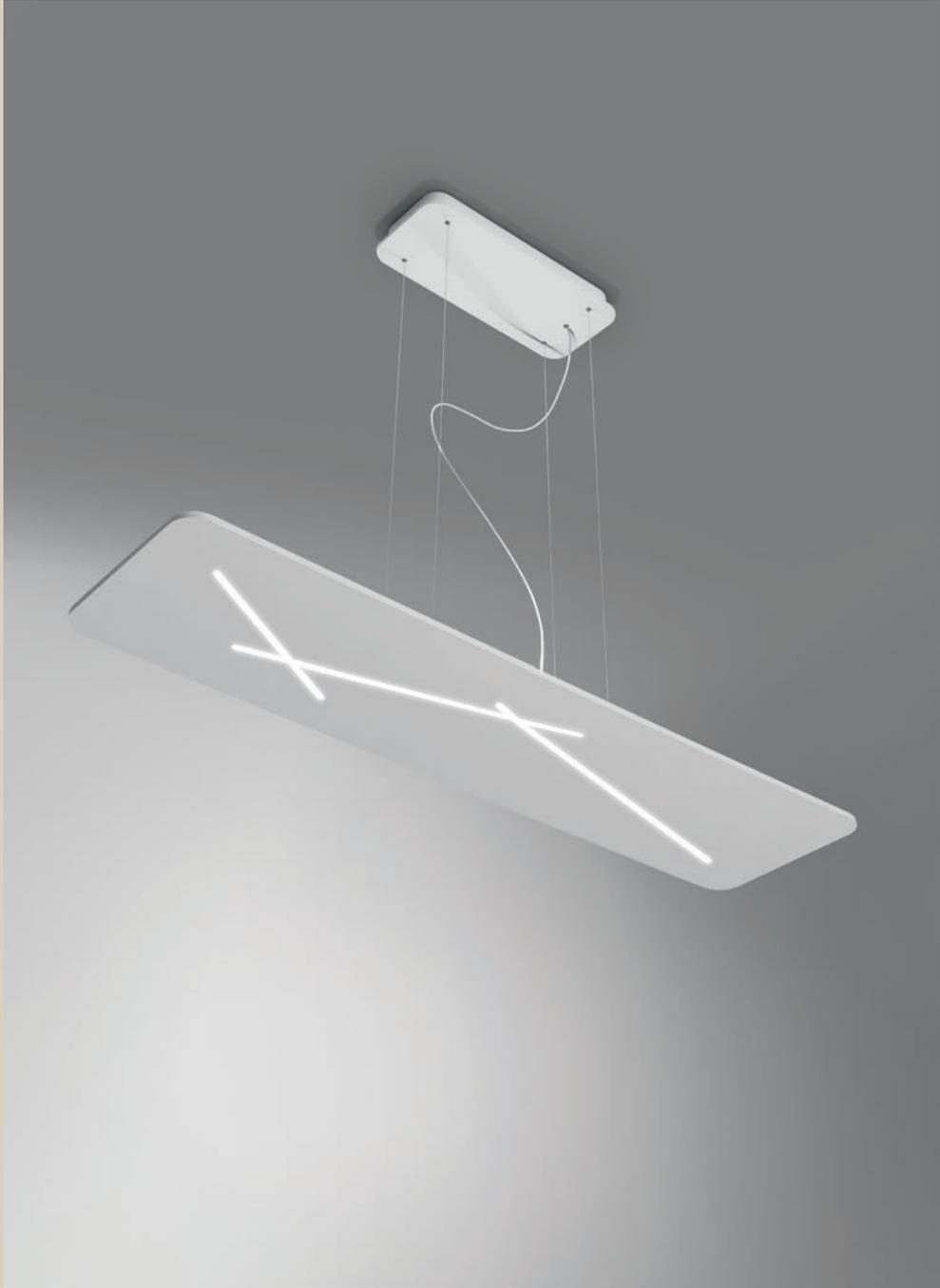

**Next** pendant luminaires







## **Technical Info**

Dimensioni e composizioni  
Sizes and compositions  
Dimensions et compositions  
Abmessungen und Zusammensetzung  
Dimensiones y composiciones  
Размеры и композиции



Next\_S | Ceiling luminaires | 220-240 V | topLED 14 W

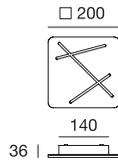

**type**

White CRI 85 **7440**

**colour**

3000 K 1035 lm

**optics**

diffused

Next\_S | Ceiling luminaires | 220-240 V | topLED 46 W

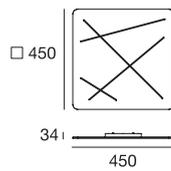

**type**

White CRI 85 **7441**

**colour**

3000 K 3312 lm

**optics**

diffused

Next\_S | Ceiling luminaires | 220-240 V | topLED 73 W

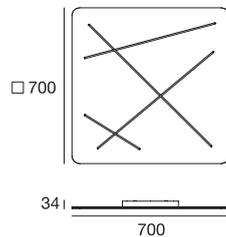

**type**

White CRI 85 **7442**

**colour**

3000 K 5244 lm

**optics**

diffused

Next\_C | Recessed Light | 220-240 V | topLED 58 W

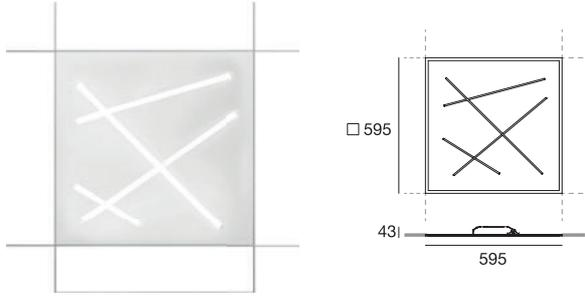

**type**

White CRI 85 **7445**

**colour**

3000 K 4140 lm

**optics**

diffused

Next\_W | Wall light | 220-240 V | topLED 21 W

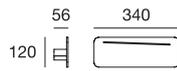
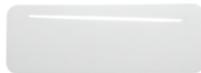

**type**

White CRI 90 **7447**

**colour**

3000 K 2505 lm

**optics**

diffused

Next  
wall light



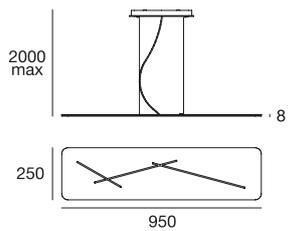

**type**

White CRI 85 **7444**

**colour**

3000 K 2760 lm

**optics**

diffused

# Wings

<sup>IT</sup> — Reinterpreta la leggerezza e l'eleganza di una scultura minimalista. Il diffusore antiabbagliante in policarbonato è posizionato sulle due sottili aste in alluminio, bianche ali di luce indiretta perfette per decorare le pareti con suggestivi giochi chiaroscurali.

<sup>FR</sup> — La réinterprétation de la légèreté et de l'élégance d'une sculpture minimaliste. Le diffuseur anti-éblouissement en polycarbonate est placé sur deux axes fins en aluminium, des ailes blanches de lumière indirecte, parfaites pour décorer les murs avec des jeux clairs-obscur suggestifs.

<sup>ES</sup> — Reinterpreta la ligereza y la elegancia de una escultura minimalista. El difusor antideslumbrante de policarbonato se encuentra en las dos varillas delgadas de aluminio, blancas alas de luz indirecta perfectas para decorar las paredes con juegos fascinantes de claroscuro.

<sup>EN</sup> — Reinventing minimal sculpture's lightness and elegance. Antiglare polycarbonate diffuser fixed on two thin aluminum rods, indirect light white wings perfect for decorating walls with suggestive chiaroscuro games.

<sup>DE</sup> — Die Neuinterpretation der Leichtigkeit und Eleganz einer minimalistischen Skulptur. Der Diffusor aus Polycarbonat mit Blendschutz sitzt auf zwei dünnen Stangen aus Aluminium und gleicht weißen Flügeln aus indirektem Licht, die die Wände mit einem eindrucksvollen Spiel aus Licht und Schatten dekorieren.

<sup>PY</sup> — Новая интерпретация легкой и элегантной минималистской скульптуры. Рассеиватель из поликарбоната с защитой от слепящего света расположен на двух тонких алюминиевых стержнях, белых крыльях отраженного света, отлично украшающих стены живописной игрой светотени.

design **Edin Dedovic**,  
**linealight**group R&D dept., 2012











Wings wall light

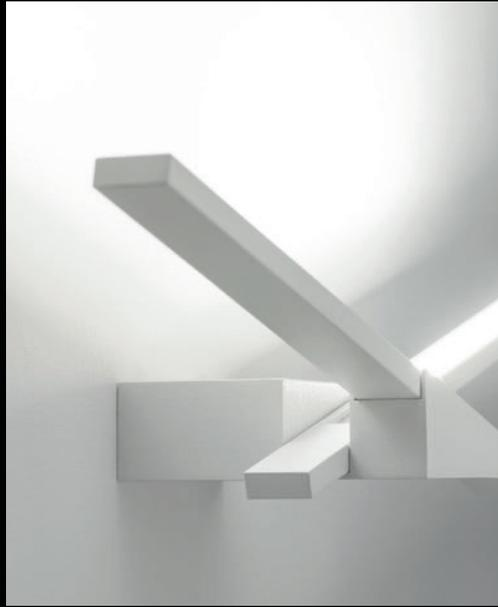

## **Technical Info**

Dimensioni e composizioni  
Sizes and compositions  
Dimensions et compositions  
Abmessungen und Zusammensetzung  
Dimensiones y composiciones  
Размеры и композиции



Wings | Wall light | 220-240 V | topLED 10 W

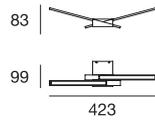

**type**

White	CRI 85	<b>7411</b>
Black	CRI 85	<b>7412</b>

**colour**

3000 K 690 lm

**optics**

diffused

Wings | Wall light | 220-240 V | topLED 19 W

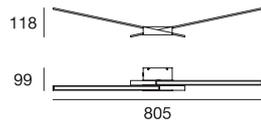

**type**

White	CRI 85	<b>7414</b>
Black	CRI 85	<b>7415</b>

**colour**

3000 K 1380 lm

**optics**

diffused

# Flurry

<sup>IT</sup> — Un'elegante e sottile diffusore è incastonato nel leggerissimo corpo rettangolare in alluminio verniciato con finitura satinata, nei colori bianco, bronzo e nero. Una scelta che garantisce un'inedita percezione sensoriale della materia.

<sup>FR</sup> — Un diffuseur élégant et fin est encastré dans le corps très léger de la lampe rectangulaire en aluminium verni avec une finition satinée, dans les couleurs blanc, bronze et noir. Un choix qui garantit une perception sensorielle unique de la matière.

<sup>ES</sup> — Un difusor elegante y fino se engasta en el cuerpo rectangular ligerísimo de aluminio pintado con acabado satinada, en los colores blanco, bronce y negro. Una elección que garantiza una percepción inédita sensorial de la materia.

<sup>EN</sup> — An elegant and thin diffuser is encapsulated in an extra-light rectangular aluminum casing, coated in a satin finish. It is available in white, bronze and black colours. A choice granting an innovative sensual material perception.

<sup>DE</sup> — Ein eleganter und schmaler Diffusor ist in einen sehr leichten, rechteckigen Leuchtenkörper aus lackiertem Aluminium mit satinierten Finish, der in den Farben Weiß, Bronze und Schwarz erhältlich ist. Eine Wahl, die für eine außergewöhnliche Sinneswahrnehmung der Materie garantiert.

<sup>PY</sup> — Элегантный тонкий рассеиватель располагается в легчайшем прямоугольном корпусе из крашеного алюминия с отделкой сатинированная, белого, бронзового или черного цвета. Благодаря этому решению фактурность воспринимается органами чувств.

design **Marco Piva**, 2016



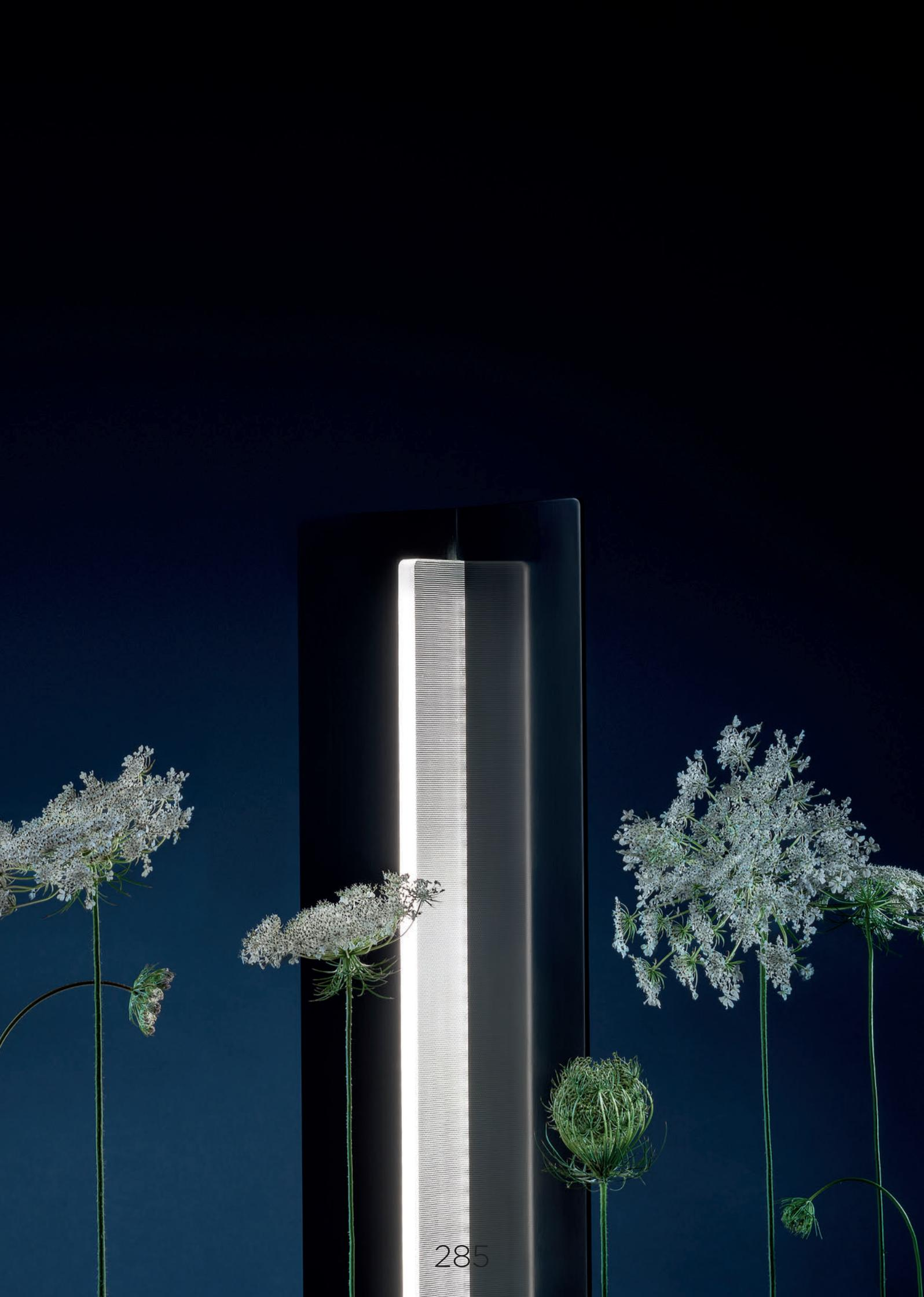

285



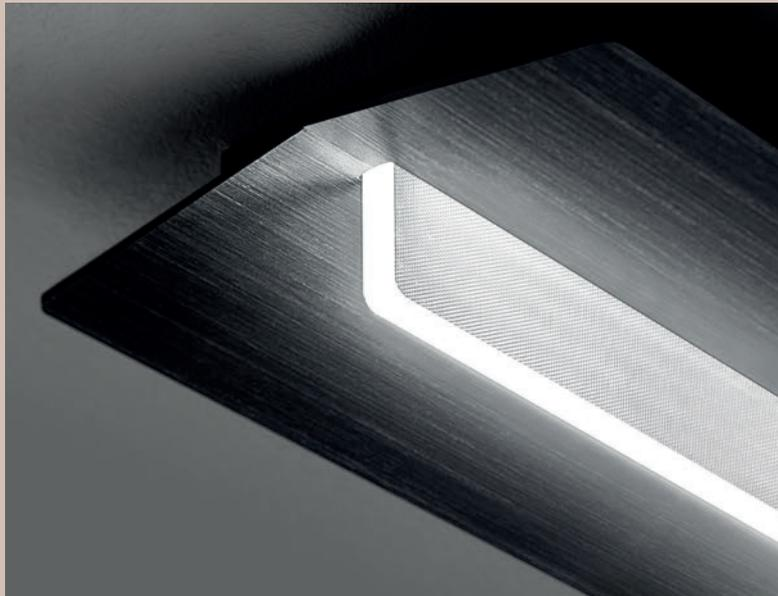

Flurry ceiling luminaires





## **Technical Info**

Dimensioni e composizioni  
Sizes and compositions  
Dimensions et compositions  
Abmessungen und Zusammensetzung  
Dimensiones y composiciones  
Размеры и композиции



Flurry | Ceiling-Wall light | 220-240 V | 24 W

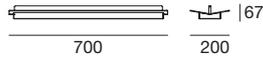

type

White	CRI 90	<b>7963</b>
Black Br.	CRI 90	<b>7964</b>
Bronze	CRI 90	<b>7965</b>

colour

3000 K 2755 lm

optics

diffused



accessories



KIT0079

CASAMBI  
DALI Dimmer  
1 art.



Flurry | Ceiling-Wall light | 220-240 V | 45 W

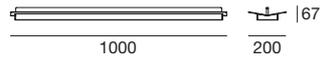

type

White	CRI 90	<b>7966</b>
Black Br.	CRI 90	<b>7967</b>
Bronze	CRI 90	<b>7968</b>

colour

3000 K 5073 lm

optics

diffused



accessories



KIT0079

CASAMBI  
DALI Dimmer  
1 art.



Flurry | Ceiling luminaires | 220-240 V | 59 W

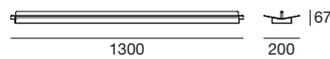

type

White	CRI 90	<b>7969</b>
Black Br.	CRI 90	<b>7970</b>
Bronze	CRI 90	<b>7971</b>

colour

3000 K 6764 lm

optics

diffused



accessories



KIT0079

CASAMBI  
DALI Dimmer  
1 art.



# Eclips

<sup>IT</sup> — Un'eclisse che oscura e dischiude una sorgente di luce perfetta. La lampada si può aprire a ventaglio, gli elementi in alluminio verniciato ruotano così come il diffusore in vetro bianco acidato, formando effetti chiaroscurali obliqui e inaspettati. Disponibile in diverse preziose combinazioni cromatiche.

<sup>FR</sup> — Une éclipse qui cache et renferme une source de lumière parfaite. Une lampe qui peut s'ouvrir en éventail, les éléments en aluminium verni tournent ainsi que le diffuseur en verre blanc dépoli, créant des effets clairs-obscurs obliques et inattendus. Disponible dans différentes combinaisons chromatiques précieuses.

<sup>ES</sup> — Un eclipse, que oscurece y descubre una fuente de luz perfecta. La lámpara se puede abrir en abanico, los elementos de aluminio pintado giran al igual que el difusor de cristal blanco acidado, para formar efectos de claroscuro oblicuos e inesperados. Disponible en distintas combinaciones cromáticas exquisitas.

<sup>EN</sup> — An eclipse that obscures and spreads up a perfect light. Eclips fans out with its rotating aluminum elements and the acid-etched white glass diffuser which create chiaroscuro oblique and unexpected lighting effects. Available in several precious chromatic combinations.

<sup>DE</sup> — Eine Eklipse, die eine perfekte Lichtquelle verdunkelt und freigibt. Die Leuchte kann wie ein Fächer geöffnet werden, ihre Elemente aus lackiertem Aluminium und der Diffusor aus weißem Ätztglas lassen sich drehen und erzeugen schräge und überraschende Hell-Dunkel-Muster. Erhältlich in verschiedenen hochwertigen Farbkombinationen.

<sup>PY</sup> — Затмение, которое затемняет и раскрывает идеальный источник света. Светильник может открываться веером, а элементы из крашеного алюминия, а также рассеиватель из белого травленого стекла вращаются, создавая необычные косые эффекты светотени. Предлагается в различных цветовых комбинациях.

design **Oriano Favaretto**, 2016







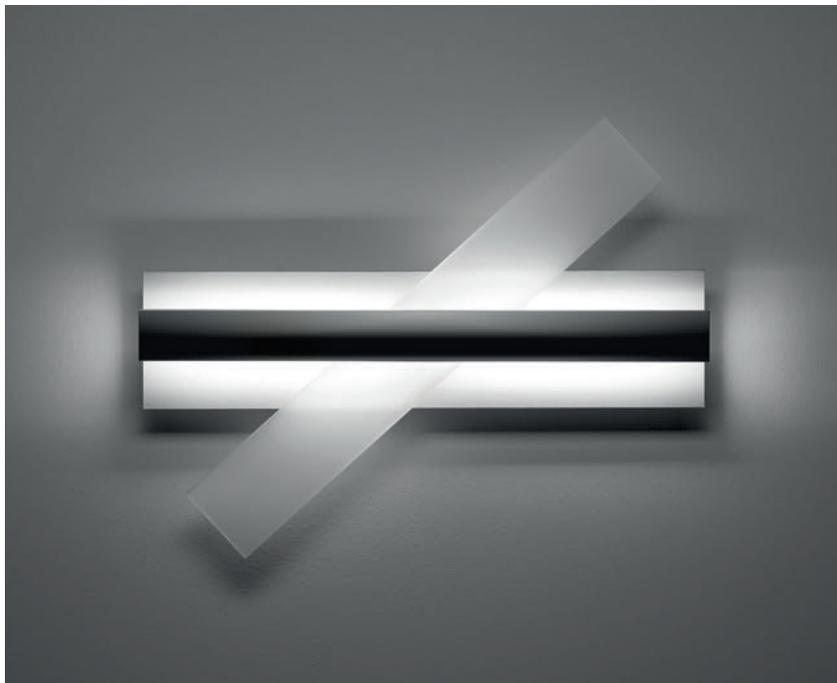
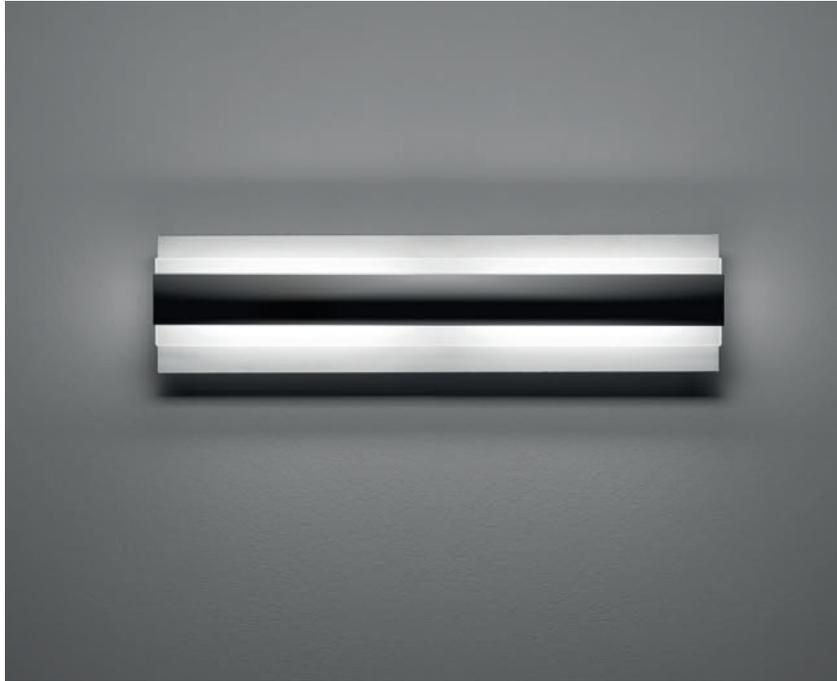

Eclips wall light





## Technical Info

Dimensioni e composizioni  
Sizes and compositions  
Dimensions et compositions  
Abmessungen und Zusammensetzung  
Dimensiones y composiciones  
Размеры и композиции



**Eclips\_W** | Ceiling-Wall light | 220-240 V | 20 W

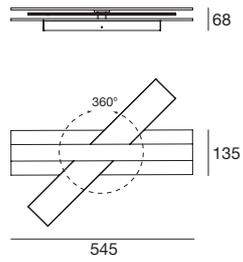

**type**

White	CRI 90	<b>8150</b>
Wh. Al.	CRI 90	<b>8151</b>
Cha. Bl.	CRI 90	<b>8152</b>
Bl. Cha.	CRI 90	<b>8153</b>

**colour**

3000 K 2422 lm

**optics**

diffused

**Eclips\_S** | Ceiling luminaires | 220-240 V | 36 W

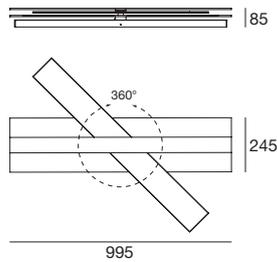

**type**

White	CRI 90	<b>8155</b>
Wh. Al.	CRI 90	<b>8156</b>
Cha. Bl.	CRI 90	<b>8157</b>
Bl. Cha.	CRI 90	<b>8158</b>

**colour**

3000 K 4269 lm

**optics**

diffused

# Dunia

<sup>IT</sup> — Un levigato masso luminoso dalle linee delicate, che origina un sapiente gioco di luci e ombre. Il corpo lampada in polietilene naturale e il diffusore, disponibile nelle varianti oro rosa, bianco opalino e con texture microprismatica, offrono una visione dinamica della luce.

<sup>FR</sup> — Un rocher poli et lumineux aux lignes délicates qui crée un savant jeu d'ombres et de lumières. Le corps de la lampe en polyéthylène naturel et le diffuseur, disponible dans la variante or rose, blanc opalin ou avec texture microprismatique, offrent une vision dynamique de la lumière.

<sup>ES</sup> — Una masa pulida luminosa con líneas delicadas, que origina un juego sabio de luces y sombras. El cuerpo de la lámpara de polietileno natural y el difusor, disponible en las variantes oro rosa, blanco opalino y con texturas microprismáticas, ofrece una visión dinámica de la luz.

<sup>EN</sup> — A polished luminous pebble defined by smooth lines. It creates interesting chiaroscuro games. The natural polyethylene casing and its diffuser are available in pink gold, opal white and with micro-prismatic texture, offering a dynamic light vision.

<sup>DE</sup> — Ein glatt geschliffener Körper mit zarten Linien, der ein elegantes Spiel aus Licht und Schatten erzeugt. Der Leuchtenkörper ist aus natürlichem Polyethylen und der Diffusor, der in den Varianten mit Oberfläche aus Rotgold oder opalem Weiß mikroprismatischer Textur erhältlich ist, bietet eine dynamische Vision des Lichts.

<sup>PY</sup> — Гладкий световой валун с деликатными линиями, создающий умелую игру света и тени. Корпус светильника из натурального полиэтилена и рассеиватель, предлагаемый в различных вариантах – розовое золото, опаловый белый или с микропризматической текстурой – придает свету динамичный облик.

design **Anton Petrov & Ilya Korchagin**, 2012-2018









Dunia pendant luminaires





## Technical Info

Dimensioni e composizioni  
Sizes and compositions  
Dimensions et compositions  
Abmessungen und Zusammensetzung  
Dimensiones y composiciones  
Размеры и композиции

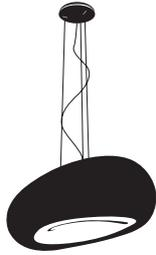

Dunia\_P | Pendant luminaires | 220-240 W | 3xE27

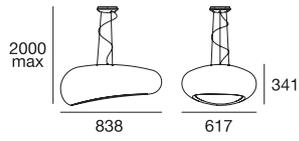

**type**

White	<b>7470</b>
Prism.	<b>7473</b>
Rose Br.	<b>7520</b>

**colour**

3x46 W max

**optics**

diffused

Dunia\_S | Ceiling luminaires | 220-240 W | 3xE27



**type**

White	<b>7471</b>
Prism.	<b>7472</b>
Rose Br.	<b>7521</b>

**colour**

3x46 W max

**optics**

diffused

# Dynamic

<sup>IT</sup> — Dynamic è un'applique dalla forma organica, dalla luce vibrante sotto al diffusore in vetro soffiato acidato. Il raffinato bianco opalino, ottenuto dalla soffiatura dei maestri vetrai muranesi, garantisce un flusso omogeneo e diffuso all'interno dello spazio.

<sup>FR</sup> — Dynamic est une applique à la forme organique. La lumière vibre sous le diffuseur en verre soufflé dépoli. Le blanc opalin raffiné, obtenu selon la technique de soufflage des maîtres verriers de Murano, garantit un flux homogène et diffus à l'intérieur de l'espace.

<sup>ES</sup> — Dynamic es un aplique con forma orgánica, con luz vibrante bajo el difusor de vidrio soplado acidado. El refinado blanco opalino, obtenido mediante soplado por los maestros del vidrio de Murano, asegura un flujo homogéneo y difuso en el interior del espacio.

<sup>EN</sup> — Dynamic is an organic shape wall light; light vibrates under the acid-etched blown glass. The refined opal white, obtained by the glassblowing of Murano Venetian masters, grants a homogeneous and diffusive light beam around the space.

<sup>DE</sup> — Dynamic ist eine Wandleuchte mit organischer Form und einem Licht, das unter dem Diffusor aus geblasenem Milchglas zu vibrieren scheint. Das elegante opale Milchglas wird von den Glasbläsermeistern auf Murano geblasen und garantiert für eine gleichmäßige Verbreitung des Lichts im Raum.

<sup>PY</sup> — Dynamic – это бра органичной формы, с рассеивателем из травленого дутого стекла, под которым пульсирует свет. Изысканный опаловый белый цвет, полученный при помощи техники дутья муранскими мастерами стекольного дела, обеспечивает однородный свет, рассеиваемый внутри пространства.

design **Manuel Remeggio**,  
**linealight**group R&D dept., 2010









Dynamic wall light





## **Technical Info**

Dimensioni e composizioni  
Sizes and compositions  
Dimensions et compositions  
Abmessungen und Zusammensetzung  
Dimensiones y composiciones  
Размеры и композиции



Dynamic | Ceiling-Wall light | 220-240 V | topLED 6 W

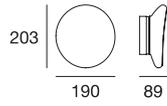

**type**

White CRI 90 **7785**

**colour**

3000 K 605 lm

**optics**

diffused

Dynamic | Ceiling-Wall light | 220-240 V | topLED 21 W

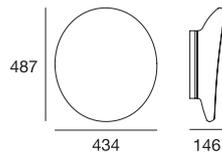

**type**

White CRI 90 **7786**

**colour**

3000 K 2794 lm

**optics**

diffused

Dynamic | Ceiling-Wall light | 220-240 V | topLED 30 W

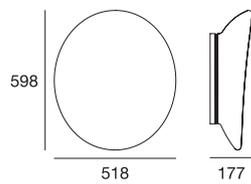

**type**

White CRI 90 **7787**

**colour**

3000 K 3929 lm

**optics**

diffused

# Moonflower

<sup>IT</sup> — LED wall ideato per arredare con la luce, giocare con il colore e dare dinamicità all'ambiente in cui è inserito. Modulare e liberamente componibile, l'elemento a vela in ABS consente, grazie a preziosi giochi di riflessione, una diffusione luminosa inedita e sempre originale.

<sup>FR</sup> — Un mur LED conçu pour décorer avec la lumière, jouer avec la couleur et dynamiser l'espace dans lequel il se trouve. Modulaire et librement composable, l'élément en forme de voile en ABS permet, grâce à de précieux jeux de réflexion, une diffusion lumineuse inédite et toujours originale.

<sup>ES</sup> — LED wall pensado para decorar con la luz, jugar con el color y regalar dinamicidad al ambiente. Modular y libremente componible, la bóveda de ABS permite, mediante juegos preciosos de reflexión, una difusión luminosa inédita y siempre original.

<sup>EN</sup> — LED wall created to furnish with lights, playing with colors and giving dynamicity to living space. Modular and freely modular, the ABS vault allows precious reflections games, an unusual lighting diffusion, always original.

<sup>DE</sup> — Die LED-Wall wurde für das Einrichten mit Licht konzipiert und verleiht dem Ambiente durch ihren spielerischen Umgang mit Farben eine ganz eigene Dynamik. Die modularen Elemente aus ABS lassen sich frei kombinieren und schaffen mit ihren verspielten Reflexionen eine ungewöhnliche und originale diffuse Beleuchtung.

<sup>PY</sup> — Светодиодная стена, предназначенная для оформления пространства, игры с цветом и придания динамичности обстановке. Этот модульный, свободно компокуемый парусный элемент из АБС позволяет, благодаря игре отблесков, получать необычный и всегда оригинальный свет.

design **Colin Johnson**, 2014

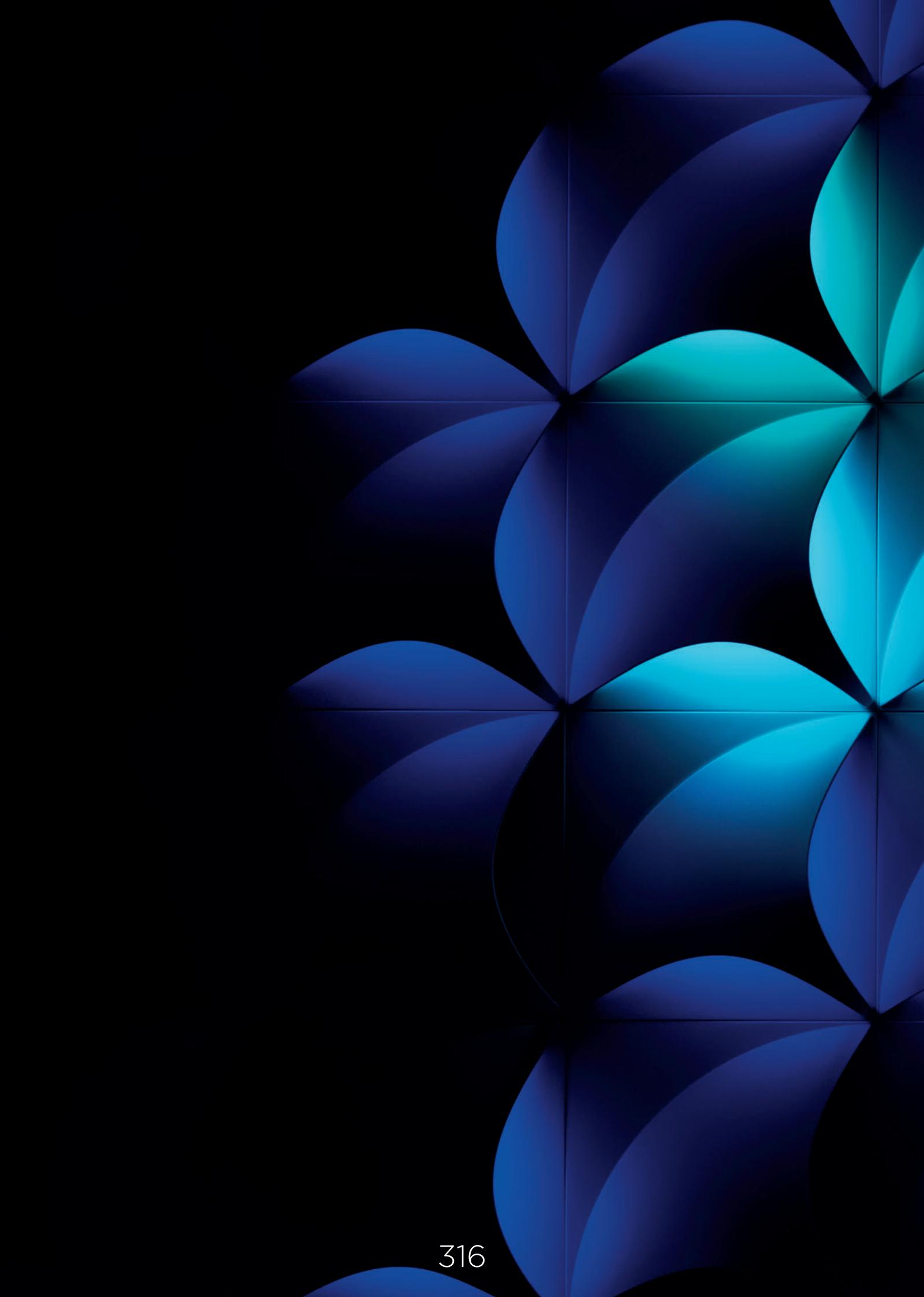

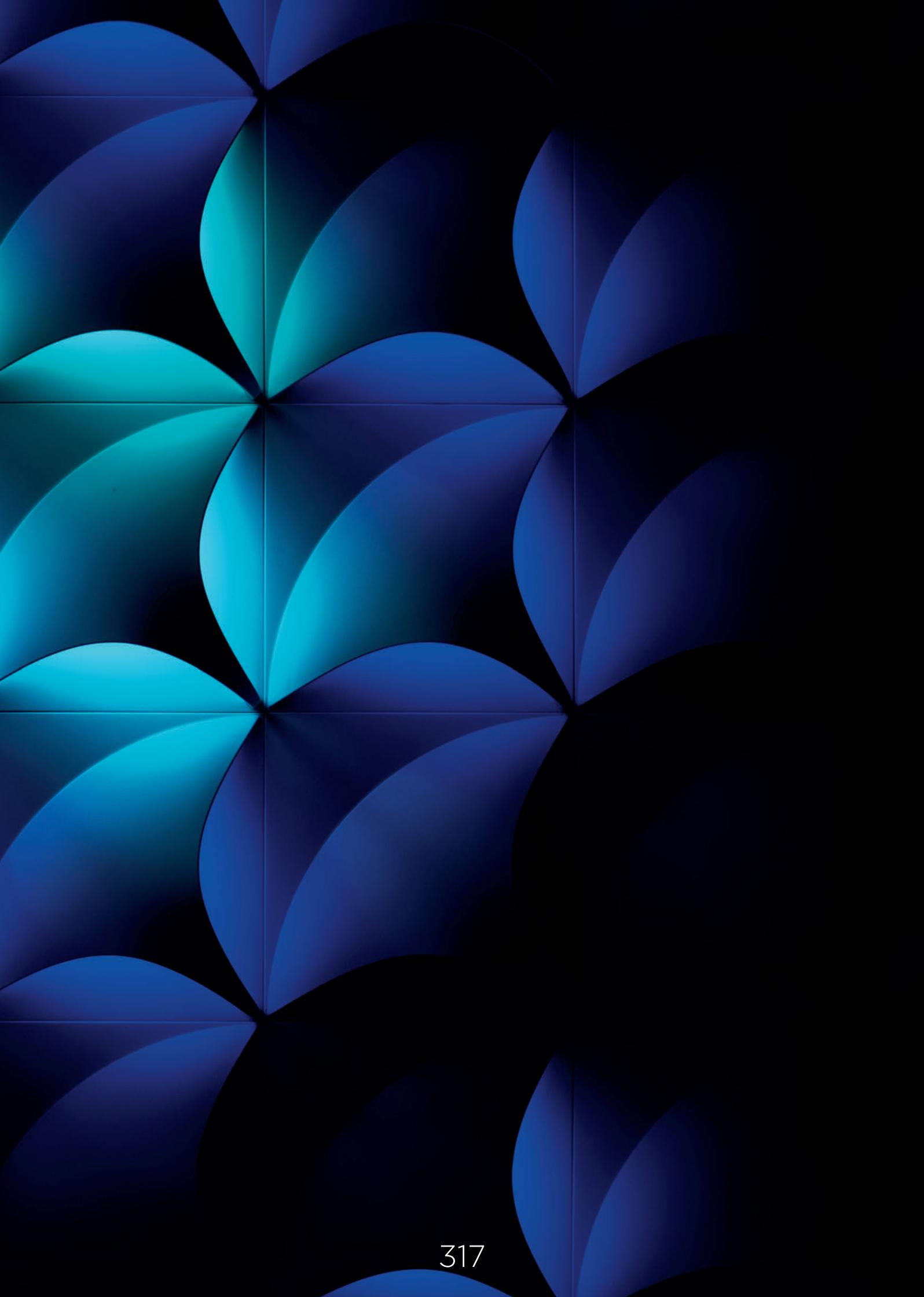



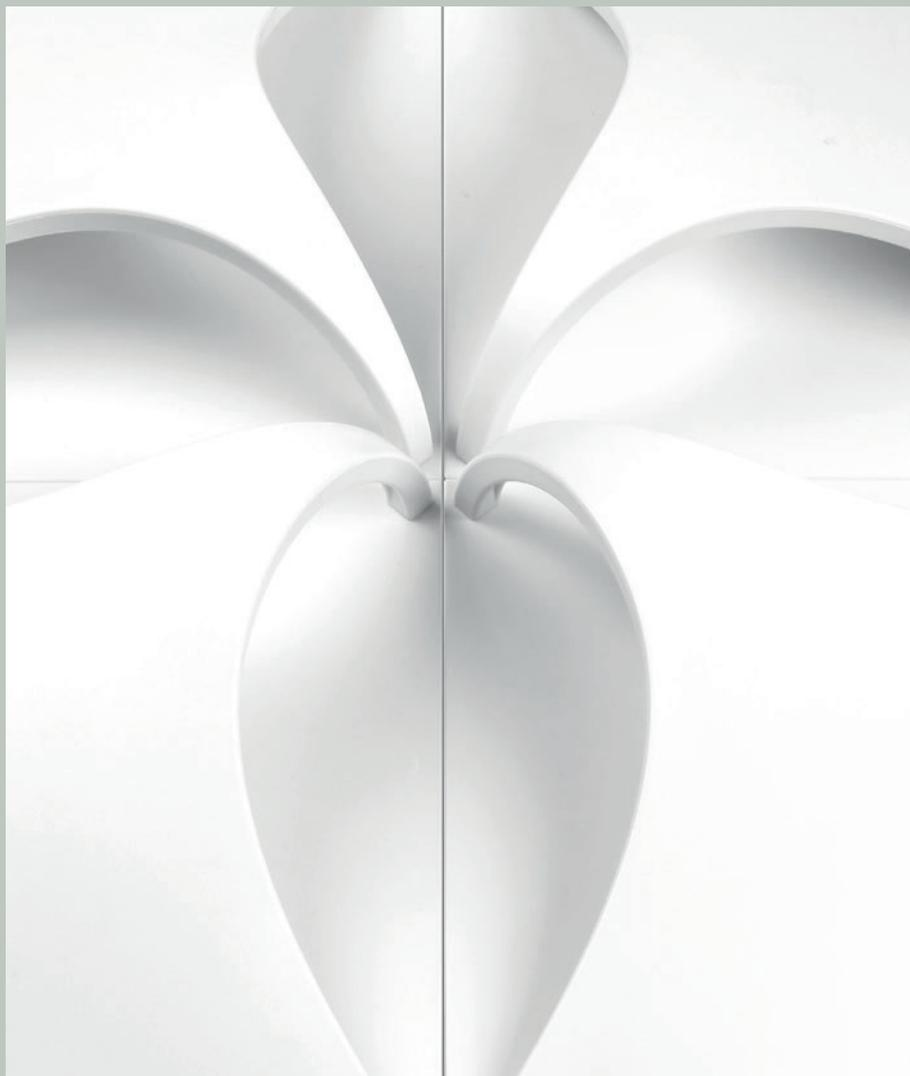

Moonflower wall light





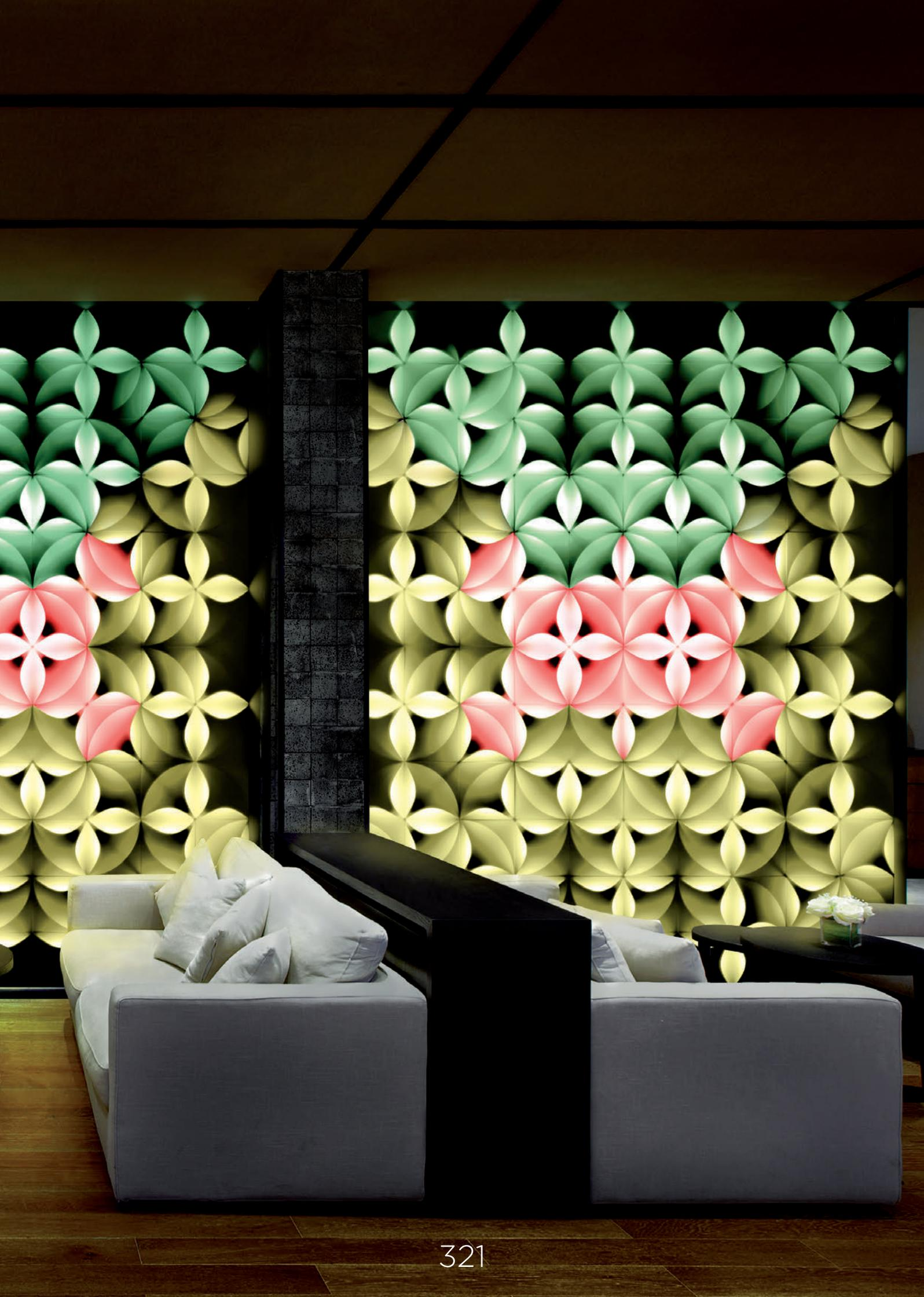

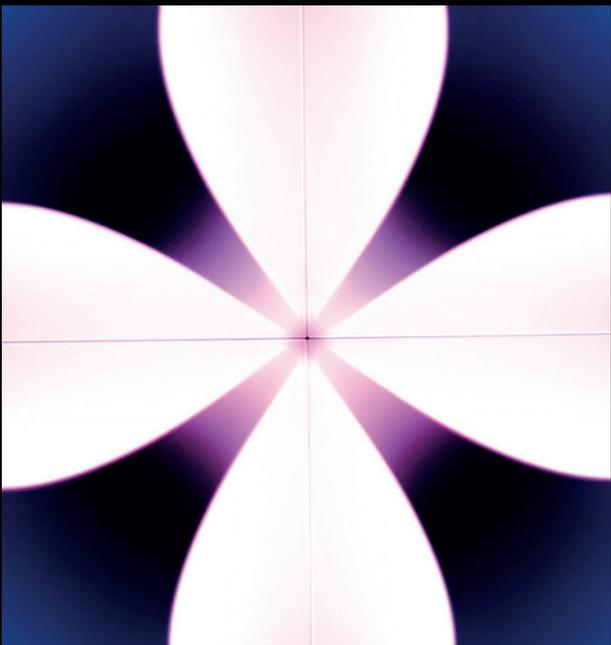
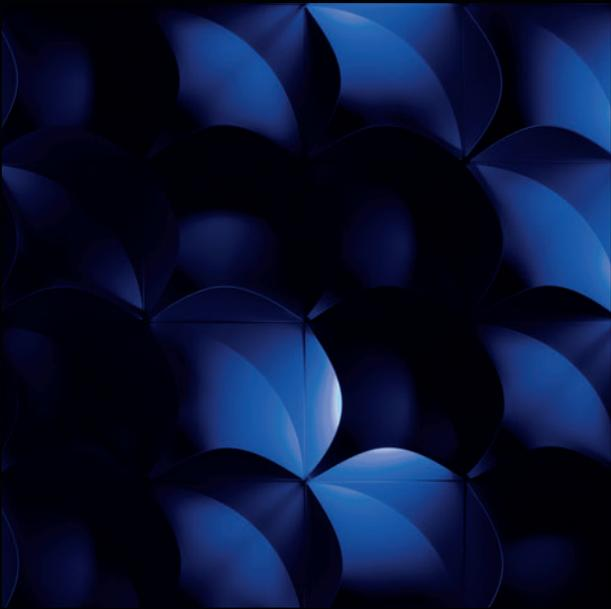

## **Technical Info**

Dimensioni e composizioni  
Sizes and compositions  
Dimensions et compositions  
Abmessungen und Zusammensetzung  
Dimensiones y composiciones  
Размеры и композиции



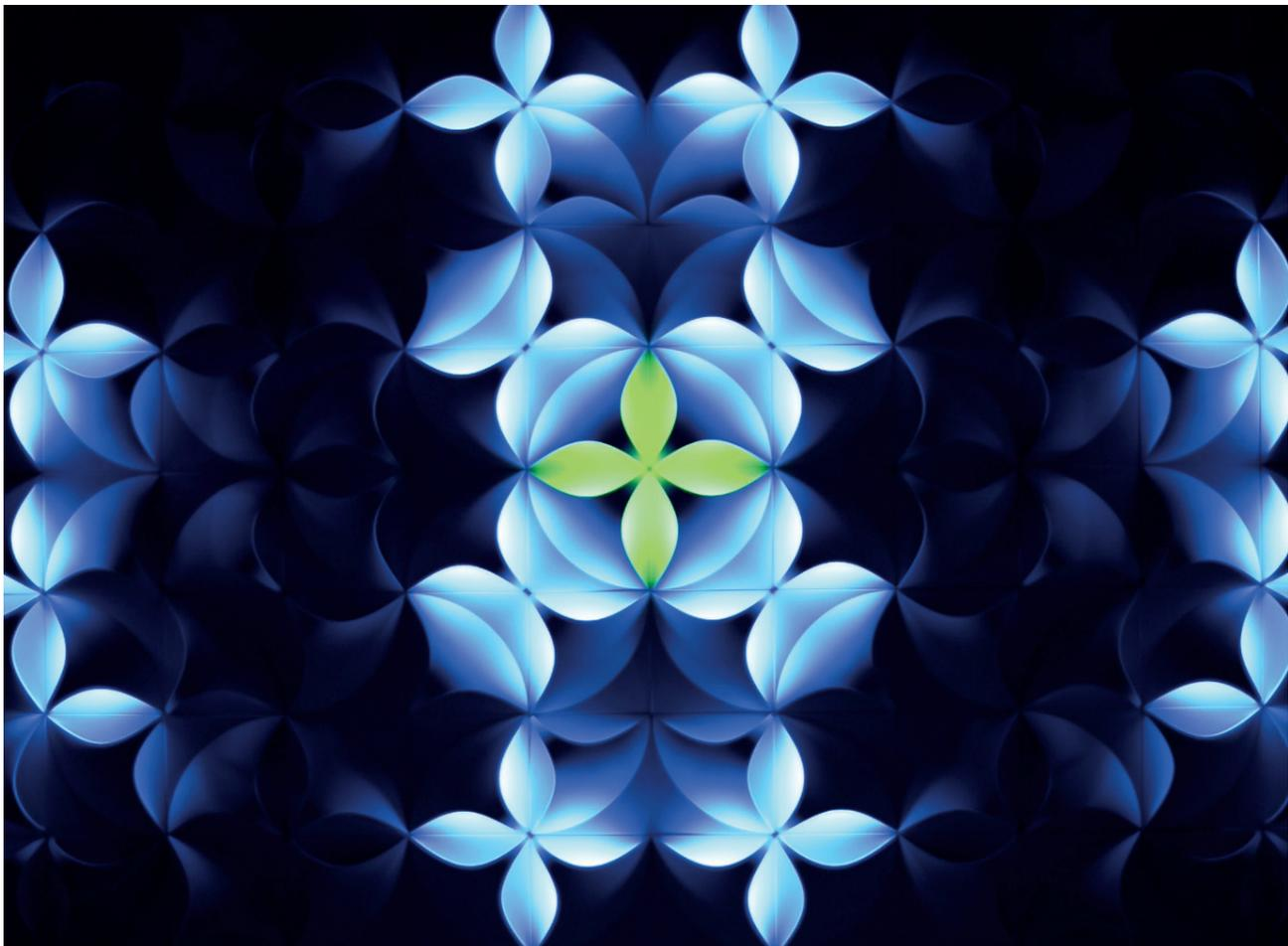
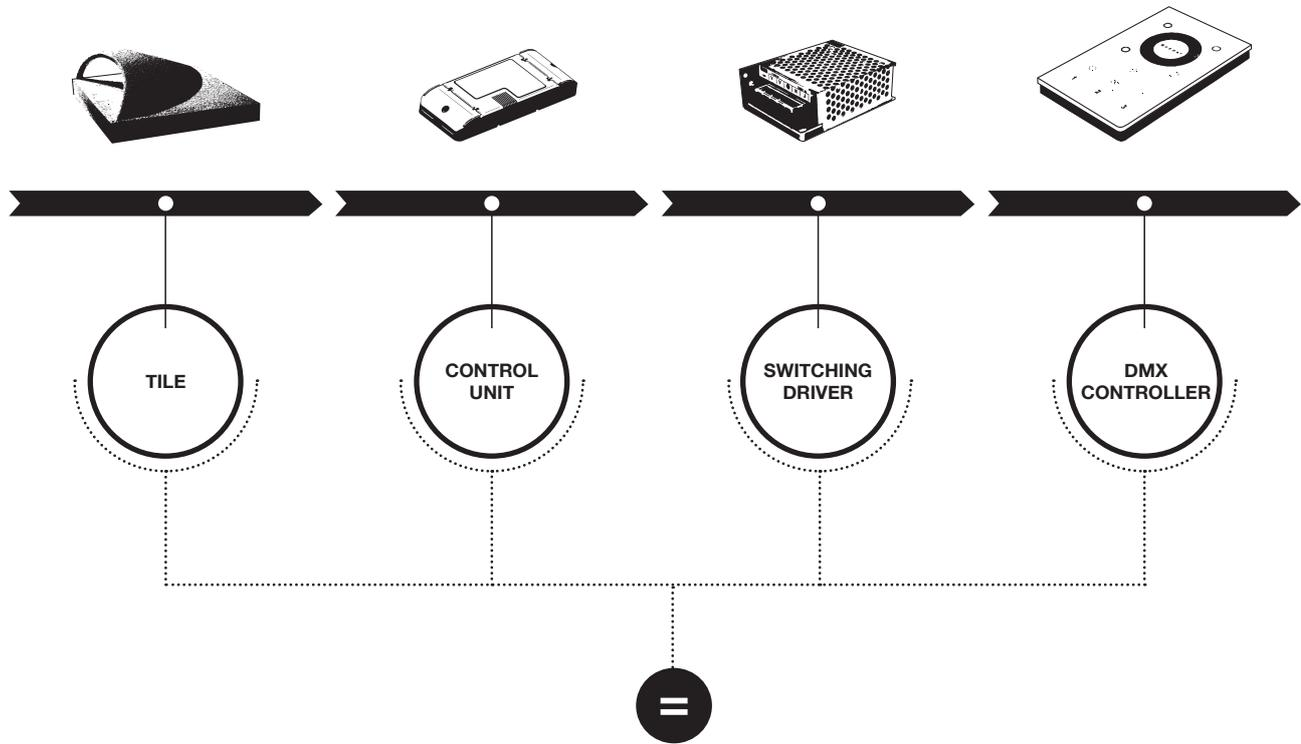

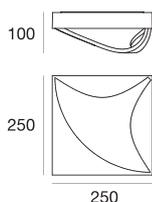

**type**

White 7760

**colour**

RGB

**optics**

diffused

**accessories**



**KIT0048**

Fixing bracket



**KIT0049**

Power Cable  
2 x 0,35 mm<sup>2</sup>  
L = 600 mm.



**KIT0050**

RGB Signa IFLAT  
Cable 6 x 0,08 mm<sup>2</sup>  
L = 320 mm.

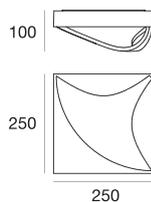

**type**

White 7761

**accessories**



**KIT0048**

Fixing bracket



linealight.com/moonflower

IT — Video, immagini, info e molto altro sul minisito dedicato. Scansiona il QR code a lato per scoprire i contenuti extra di Moonflower. Per progetti DMX contattate il dipartimento di progettazione [support@linealight.com](mailto:support@linealight.com)

FR — Des vidéos, des photos, des infos et beaucoup d'autres choses sur le site dédié. Lire le code QR sur le côté pour découvrir des contenus supplémentaires de Moonflower. Pour des projets DMX, contactez le service conception [support@linealight.com](mailto:support@linealight.com)

ES — Vídeos, imágenes, información y mucho más en el minisito dedicado. Escanea el código QR de al lado para descubrir los contenidos extra de Moonflower. Para proyectos DMX, pónete en contacto con la sección de diseño [support@linealight.com](mailto:support@linealight.com)

EN — Videos, pictures, information and much more on the dedicated mini-website. Scan the QR code at the side to discover Moonflower extra content. For DMX projects please contact the design department [support@linealight.com](mailto:support@linealight.com)

DE — Auf der Mini-Webseite gibt es Videos, Bilder, Infos und vieles mehr. Scannen Sie den QR-Code ein und entdecken Sie viele interessante Informationen über Moonflower. Für DMX-Projekte kontaktieren Sie bitte unsere Planungsabteilung unter [support@linealight.com](mailto:support@linealight.com)

PY — Видео, изображения и много другое представлены на специальном минисайте. Выполните сканирование расположенного сбоку QR-кода и узнайте дополнительную информацию о Moonflower. Для DMX-проектов свяжитесь с проектным отделом [support@linealight.com](mailto:support@linealight.com)



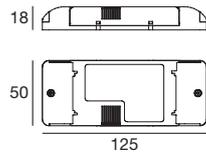

range	output	input	PF	
Power 1ch x (1-60 LEDs/ch)	2,5A	24 V DC	0,97	<b>KIT0011</b>
Signal 3+3ch x (1-1000 LEDs/ch)				

**accessories**



**KIT0053**

Cable for DMX signal wiring  
DMX version  
3x0,25 mm<sup>2</sup>  
L= 1200 mm.



**KIT0054**

Cable for Controller wiring  
Stand Alone version  
2x0,5 mm<sup>2</sup>  
L= 400 mm.

IT — Gestione di 21 programmi precaricati (5 di evanescenza e 16 a scenario fisso) tramite pulsanti N/A, in modalità master/slave stand alone. Compatibile con protocollo DMX 512 per gestione di scenari avanzati.

EN — Management of 21 preset programmes (5 fade and 16 static backdrop) through NO buttons, in master/slave stand alone mode. Compatible with DMX 512 protocol to manage advanced backdrops.

FR — Gestion de 21 programmes préchargés (5 d'évanescence et 16 à scénarios fixes) à l'aide de boutons NO, en mode master/slave stand alone. Compatible avec le protocole DMX 512 pour la gestion de scénarios avancés.

DE — Verwaltung von 21 voreingestellten Programmen (5 abklingende Programme und 16 mit festem Szenario) über NO-Tasten in der Modalität Master/Slave Standalone. Kompatibel mit Protokoll DMX512 für die Verwaltung erweiterter Szenarien.

ES — Gestión de 21 programas precargados (5 de desvanecimiento y 16 con escenario fijo) mediante pulsadores NO, en el modo master/slave stand alone. Compatible con el protocolo DMX 512 para la gestión de escenarios avanzados.

PY — Управление предварительно загруженными 21 программами (5 замирания и 16 с фиксированным сценарием) при помощи кнопок NO, в режиме отдельностоящего ведущего/ведомого устройства. Совместим с протоколом DMX 512 для управления продвинутыми сценариями.

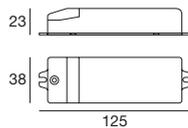

output	input	PF	
29 W 24 V	220~240 V DC	0.97	<b>KIT0019</b>

**accessories**



**KIT0052**

Cable  
2x1 mm<sup>2</sup>  
L= 600 mm.



**KIT0051**

Splitter  
4xM - 2xM connectors  
24V 3A - 24V 6A in/out

IT — Alta efficienza e PF elevato. Protezione autoripristinante contro il circuito aperto ed il cortocircuito lungo la linea in uscita. Compatibile con max. 20 piastrelle (Stand Alone). Per ogni centralina DMX aggiunta togliere 2 piastrelle.

EN — High efficiency and power factor. Self-restoring protection against open circuits and short circuits on the output line. Compatible with a maximum of 20 tiles (stand alone). When adding a DMX control unit, remove 2 tiles.

FR — Haute efficacité et FP élevé. Protection à réarmement automatique contre le circuit ouvert et le court-circuit le long de la ligne en sortie. Compatible avec 20 plaques maximum (stand alone). Pour chaque boîtier DMX ajouté, enlever 2 plaques.

DE — Hohe Effizienz und hoher Leistungsfaktor. Schutz mit automatischer Rückstellung vor offenem Schaltkreis und Kurzschluss an der Ausgangsleitung. Kompatibel mit max. 20 Paneelen (Standalone). Für jedes hinzugefügte DMX Steuergerät müssen 2 Paneele abgezogen werden.

ES — Eficiencia alta y PF elevado. Protección de autorestablecimiento contra el circuito abierto y el cortocircuito en la línea en salida. Compatible con al máximo 20 baldosas (stand alone). Por cada centralita DMX añadida, se han de quitar 2 baldosas.

PY — Высокая эффективность и повышенный фактор мощности. Самовосстанавливающая защита против разомкнутого контура и короткого замыкания вдоль выходящей линии. Совместим с максимум 20 плитками (отдельностоящий). Для каждого дополнительного блока DMX следует убрать 2 плитки.

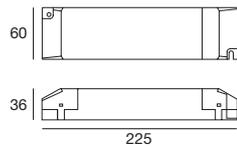

output	input	PF	
70 W 24 V	220~240 V DC	0.97	<b>KIT0020</b>

**accessories**



**KIT0052**  
Cable  
2x1 mm<sup>2</sup>  
L= 600 mm.



**KIT0051**  
Splitter  
4xM - 2xM connectors  
24V 3A - 24V 6A in/out

**IT** — Alta efficienza e PF elevato. Protezione autoripristinante contro il circuito aperto ed il cortocircuito lungo la linea in uscita. Compatibile con max. 65 piastrelle. Per ogni centralina DMX aggiunta togliere 2 piastrelle.

**EN** — High efficiency and power factor. Self-restoring protection against open circuits and short circuits on the output line. Compatible with a maximum of 65 tiles (stand alone). When adding a DMX control unit, remove 2 tiles.

**FR** — Haute efficacité et FP élevé. Protection à réarmement automatique contre le circuit ouvert et le court-circuit le long de la ligne en sortie. Compatible avec 65 plaques maximum (stand alone). Pour chaque boîtier DMX ajouté, enlever 2 plaques.

**DE** — Hohe Effizienz und hoher Leistungsfaktor. Schutz mit automatischer Rückstellung vor offenem Schaltkreis und Kurzschluss an der Ausgangsleitung. Kompatibel mit max. 65 Paneelen (Standalone). Für jedes hinzugefügte DMX Steuergerät müssen 2 Paneele abgezogen werden.

**ES** — Eficiencia alta y PF elevado. Protección de autorestablecimiento contra el circuito abierto y el cortocircuito en la línea en salida. Compatible con al máximo 65 baldosas (stand alone). Por cada centralita DMX añadida, se han de quitar 2 baldosas.

**PY** — Высокая эффективность и повышенный фактор мощности. Самовосстанавливающая защита против разомкнутого контура и короткого замыкания вдоль выходящей линии. Совместим с максимум 65 плитками (отдельностоящий). Для каждого дополнительного блока DMX следует убрать 2 плитки.

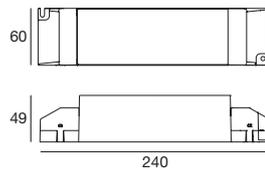

output	input	PF	
150 W 24 V	220~240 V DC	0.97	<b>KIT0021</b>

**accessories**



**KIT0052**  
Cable  
2x1 mm<sup>2</sup>  
L= 600 mm.



**KIT0051**  
Splitter  
4xM - 2xM connectors  
24V 3A - 24V 6A in/out

**IT** — Alta efficienza e PF elevato. Protezione autoripristinante contro il circuito aperto ed il cortocircuito lungo la linea in uscita. Compatibile con max. 130 piastrelle. Per ogni centralina DMX aggiunta togliere 2 piastrelle.

**EN** — High efficiency and power factor. Self-restoring protection against open circuits and short circuits on the output line. Compatible with a maximum of 130 tiles (stand alone). When adding a DMX control unit, remove 2 tiles.

**FR** — Haute efficacité et FP élevé. Protection à réarmement automatique contre le circuit ouvert et le court-circuit le long de la ligne en sortie. Compatible avec 130 plaques maximum (stand alone). Pour chaque boîtier DMX ajouté, enlever 2 plaques.

**DE** — Hohe Effizienz und hoher Leistungsfaktor. Schutz mit automatischer Rückstellung vor offenem Schaltkreis und Kurzschluss an der Ausgangsleitung. Kompatibel mit max. 130 Paneelen (Standalone). Für jedes hinzugefügte DMX Steuergerät müssen 2 Paneele abgezogen werden.

**ES** — Eficiencia alta y PF elevado. Protección de autorestablecimiento contra el circuito abierto y el cortocircuito en la línea en salida. Compatible con al máximo 130 baldosas (stand alone). Por cada centralita DMX añadida, se han de quitar 2 baldosas.

**PY** — Высокая эффективность и повышенный фактор мощности. Самовосстанавливающая защита против разомкнутого контура и короткого замыкания вдоль выходящей линии. Совместим с максимум 130 плитками (отдельностоящий). Для каждого дополнительного блока DMX следует убрать 2 плитки.

**Stick\_DE3** | DMX Controller

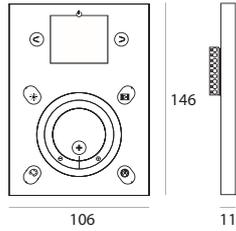

type	signal output	connector	input	
White	DMX	CLAMP RJ45 mini USB	5.5~6V DC	<b>99234</b>
Black	DMX	CLAMP RJ45 mini USB	5.5~6V DC	<b>99235</b>



**99184**  
Power supply



**84895**  
1 m cable  
F 3 pin XLR



**84994**  
5 m cable  
F 3 pin XLR



**89189**  
5 m cable  
M 5 pin M12



**98140**  
Outer casing

**Stick\_GU2** | DMX Controller

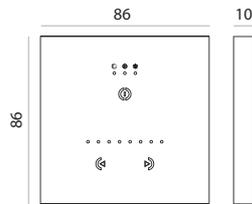
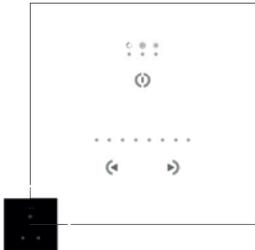

type	signal output	connector	input	
White	DMX	CLAMP micro USB	5.5~12V DC	<b>99045</b>
Black	DMX	CLAMP micro USB	5.5~6V DC	<b>99046</b>



**99184**  
Power supply



**84895**  
1 m cable  
F 3 pin XLR



**84994**  
5 m cable  
F 3 pin XLR



**89189**  
5 m cable  
M 5 pin M12



**98140**  
Outer casing

**Slesa\_UE7** | DMX Controller

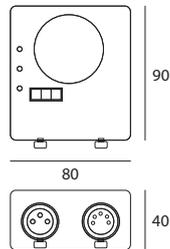

type	signal output	connector	input	
Black	DMX	RJ45 XLR 3 Pin F. XLR 5 Pin F. mini USB	5.5~6V DC	<b>99050</b>



**89186**  
5 m extension  
M 5 pin M12  
M 3 pin XLR



**98493**  
5 m extension  
M 5 pin M12  
M 5 pin XLR



**84885**  
5 m extension  
M + F3 pin  
XLR



**84869**  
Connector  
M 3 pin XLR



**99346**  
Connector  
M 5 pin XLR



**84865**  
DMX cable



IT — Per maggiori informazioni riguardo ai prodotti sopra citati, consultare pagine riportate nel catalogo tecnico Maestro "Professional LED Lighting".

DE — Mehr Informationen über die oben genannten Produkte finden Sie auf den entsprechenden Seite im technischen Katalog Maestro "Professional LED Lighting".

EN — For additional information on the abovementioned products, please refer to the pages on the technical catalogue Maestro "Professional LED Lighting".

ES — Para obtener información adicional sobre los productos anteriormente citados, consulta las páginas indicadas en el catálogo técnico Maestro "Professional LED Lighting".

FR — Pour plus d'informations concernant les produits cités, consulter le catalogue technique Maestro « Professional LED Lighting » aux pages indiquées.

PY — Дополнительную информацию о вышеуказанных продуктах можно найти на страницах технического каталога Maestro "Professional LED Lighting".



Stand Alone	<b>4 x 7760</b> 8 x KIT0048 3 x KIT0049 3 x KIT0050	<b>1 x KIT0011</b> 1 x KIT0054	<b>1 x KIT0019</b> 1 x KIT0052	
	<b>4 x 7760</b> 8 x KIT0048 3 x KIT0049 3 x KIT0050	<b>1 x KIT0011</b> 1 x KIT0053	<b>1 x KIT0019</b> 1 x KIT0052	99234 99235 1 x 99045 99046 99050

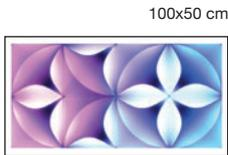

Stand Alone	<b>8 x 7760</b> 20 x KIT0048 7 x KIT0049 7 x KIT0050	<b>1 x KIT0011</b> 1 x KIT0054	<b>1 x KIT0019</b> 1 x KIT0052	
	<b>8 x 7760</b> 20 x KIT0048 7 x KIT0049 7 x KIT0050	<b>4 x KIT0011</b> 3 x KIT0053	<b>1 x KIT0019</b> 2 x KIT0051 2 x KIT0052	99234 99235 1 x 99045 99046 99050



Stand Alone	<b>24 x 7760</b> 76 x KIT0048 23 x KIT0049 23 x KIT0050	<b>1 x KIT0011</b> 1 x KIT0054	<b>2 x KIT0019</b> 1 x KIT0051 1 x KIT0052	
	<b>24 x 7760</b> 76 x KIT0048 23 x KIT0049 23 x KIT0050	<b>12 x KIT0011</b> 11 x KIT0053	<b>2 x KIT0020</b> 6 x KIT0051 6 x KIT0052	99234 99235 1 x 99045 99046 99050

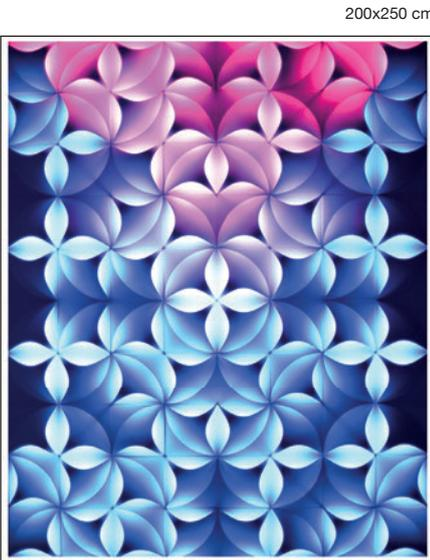

Stand Alone	<b>80 x 7760</b> 284 x KIT0048 79 x KIT0049 79 x KIT0050	<b>1 x KIT0011</b> 1 x KIT0054	<b>1 x KIT0021</b> 3 x KIT0051 3 x KIT0052	
	<b>80 x 7760</b> 284 x KIT0048 79 x KIT0049 79 x KIT0050	<b>40 x KIT0011</b> 39 x KIT0053	<b>2 x KIT0021</b> 20 x KIT0051 20 x KIT0052	99234 99235 1 x 99045 99046 99050

# Bulbo collection

<sup>IT</sup> — Tecnologia al servizio della natura, per la crescita delle piante in luoghi privi di luce solare. Versatili e curate nel design, le lampade della collezione Bulbo sono pensate per regalare la gioia del verde giorno dopo giorno.

<sup>FR</sup> — La technologie au service de la nature et de la croissance des plantes dans des lieux privés de la lumière du soleil. Polyvalentes et dotées d'un design soigné, les lampes de la collection Bulbo sont conçues pour offrir la joie de la nature, jour après jour.

<sup>ES</sup> — Tecnología al servicio de la naturaleza, para el crecimiento de plantas en lugares sin la luz del sol. Las lámparas de la colección Bulbo, versátiles y cuidadas, se han pensado para regalar la alegría del verde todos los días.

<sup>EN</sup> — Technology at the service of nature, for the growth of plants in places without sunlight. Versatile and carefully designed, the luminaires in the Bulbo collection are designed to allow the enjoyment of greenery day after day.

<sup>DE</sup> — Technologie im Dienst der Natur, um Pflanzen an Orten wachsen zu lassen, an denen es kein Sonnenlicht gibt. Die vielseitigen Leuchten der Kollektion Bulbo mit ansprechendem Design sind dafür gedacht, jeden Tag die Freude grüner Pflanzen zu schenken.

<sup>PY</sup> — Технология на службе у природы для выращивания растений в помещениях, лишенных солнечного света. Универсальные светильники коллекции Bulbo отличаются продуманным дизайном и предназначены для того, чтобы дарить радость день за днем.

design **Lorenzo Antonioni**, 2016-2018



09/104

332



333





Chlorophyll plant lamp





Reika linear profile





## **Technical Info**

Dimensioni e composizioni  
Sizes and compositions  
Dimensions et compositions  
Abmessungen und Zusammensetzung  
Dimensiones y composiciones  
Размеры и композиции



## Bulbo collection

IT — Le lampade Bulbo Collection emettono una luce colorata, frutto della combinazione di frequenze luminose selezionate per attivare il processo di fotosintesi e stimolare la crescita delle piante anche in ambienti poco illuminati o privi di luce. Lo speciale spettro luminoso, studiato presso i laboratori del Dipartimento di Scienze Agrarie dell'Università di Bologna - Alma Mater Studiorum, riproduce ciò che naturalmente le piante assorbono dalla luce del sole. Per i migliori risultati, ogni lampada andrà accesa e spenta regolarmente per riprodurre il naturale ciclo giorno/notte. Consigliato: 15 ore ON e 9 ore OFF.

DE — Die Leuchten der Kollektion Bulbo strahlen ein farbiges Licht ab, das aus verschiedenen Lichtfrequenzen besteht, die ausgewählt wurden, um die Photosynthese und das Pflanzenwachstum auch in Räumen mit wenig Tageslicht oder ohne Tageslicht anzuregen. Das spezielle Lichtspektrum, das in den Labors der Fakultät für Agrarwissenschaften der Universität Bologna, Alma Mater Studiorum, erforscht wird, entspricht dem von den Pflanzen aufgenommenen Sonnenlicht. Die besten Ergebnisse lassen sich erzielen, wenn die Lampe regelmäßig ein- und ausgeschaltet wird, um den natürlichen Tag- und Nachtzyklus nachzuahmen. Vorgeschlagen: 15 Stunden ON und 9 Stunden OFF.

EN — Thanks to their researched light frequencies, the Bulbo Collection products give plants the ideal light nutrition they need. The unique light spectrum, result of scientific researches in collaboration with the Department of Agricultural Sciences at the University of Bologna, reproduces what plants naturally absorb from the light of the sun and activates photosynthesis also in dark spaces. For the best results each lamp must be turned on and off to reproduce a natural day/night cycle. Suggested: 15 hours ON and 9 hours OFF.

ES — Las lámparas Bulbo Collection emiten una luz de color, obtenida por la combinación de frecuencias luminosas, seleccionadas para activar el proceso de fotosíntesis y estimular el crecimiento de las plantas también en ambientes con poca iluminación o sin luz. El espectro luminoso especial, estudiado en los laboratorios del Departamento de Agronomía de la Universidad de Bolonia - Alma Mater Studiorum, reproduce lo que, naturalmente, las plantas absorben de la luz solar. Para obtener los mejores resultados, cada lámpara se ha de encender y apagar regularmente para reproducir el ciclo natural día/noche. Sugerido: 15 horas ON y 9 horas OFF.

FR — Les lampes de la collection Bulbo émettent une lumière colorée, fruit de la combinaison de fréquences lumineuses sélectionnées pour activer le processus de photosynthèse et stimuler la croissance des plantes, même dans des espaces peu éclairés ou sans lumière. Le spectre lumineux spécial, étudié dans les laboratoires du Département des Sciences Agronomiques de l'Université de Bologne, Alma Mater Studiorum, reproduit ce que les plantes absorbent naturellement de la lumière du soleil. Pour de meilleurs résultats, chaque lampe devra être allumée et éteinte régulièrement pour reproduire le cycle naturel jour/nuit. Suggéré: 15 heures ON et 9 heures OFF.

PY — Светильники Bulbo Collection излучают цветной свет, результат комбинации отобранных световых частот, которые запускают процесс фотосинтеза и стимулируют рост растений, даже в малоосвещенных помещениях и помещениях, лишенных естественного света. Особый световой спектр, изученный в лабораториях Отделения сельскохозяйственных наук университета г. Болонья Alma Mater Studiorum, воспроизводит то, что растения обычно поглощают с солнечным светом. Результатов следует регулярно включать и выключать лампы с целью воспроизведения цикла день/ночь. Предлагается: 15 часов ON и 9 часов OFF.

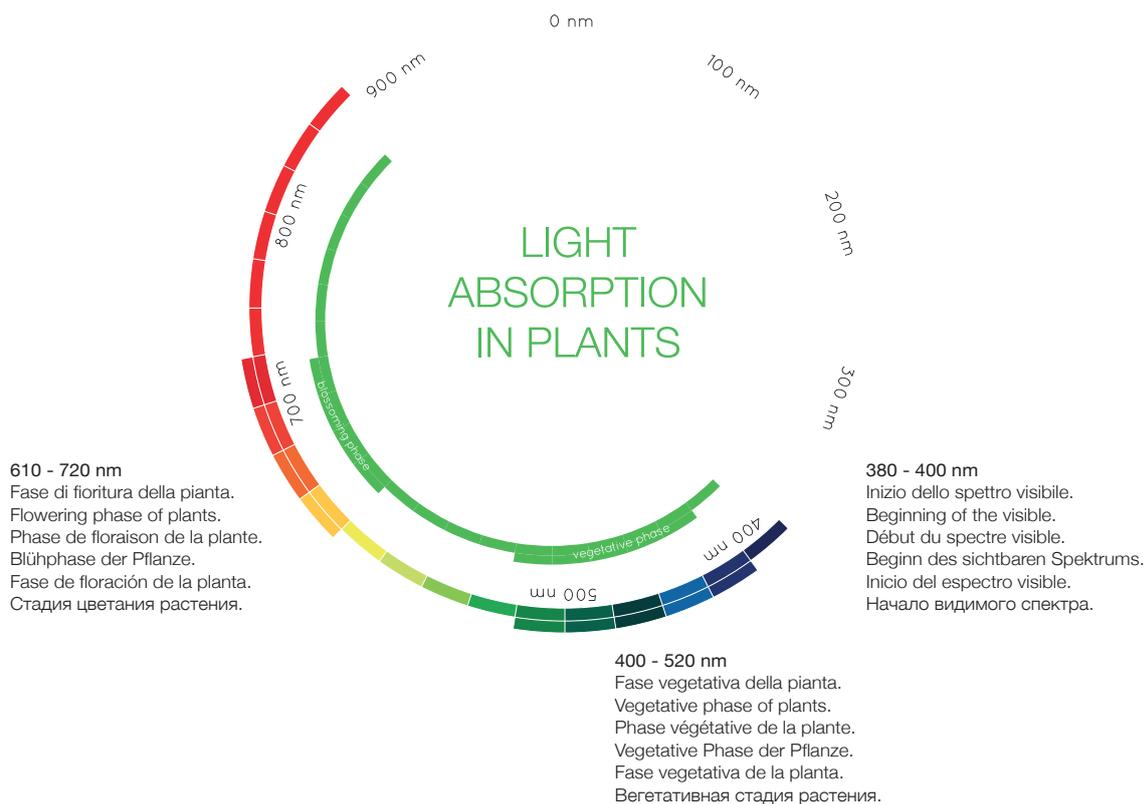

---

**Chlorophyll\_Bulbo collection**

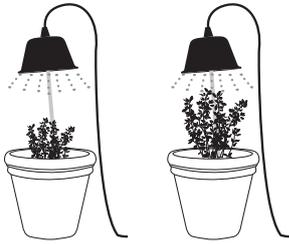

Planted in the soil



Suspended overhead by its cord from an existing support

---

**Thin\_Reika\_Bulbo collection**

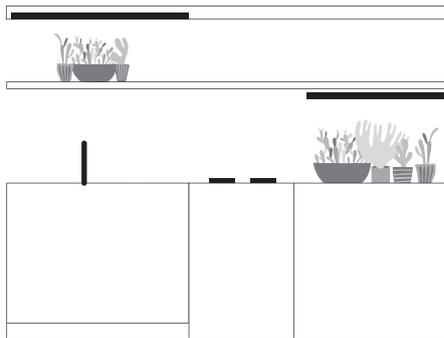

Under shelves or wall units  
Retail/contract/residential applications



Thin  
Diffused emission

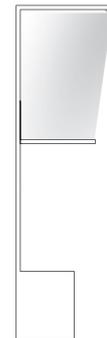

Reika  
Asymmetric emission

---

**Vertical\_Bulbo collection**

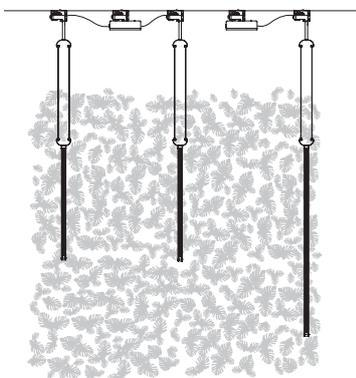

For green wall



For suspended or large plants



Thin\_Bulbo collection | Linear profiles | 220-240 V | powerLED 12 W



**type** Anod. Al. **8562** **colour** RWB **optics** diffused

Anod. Al. **8563** feat timer

15 h. **ON** 9 h. **OFF** Anod. Al.

**electronics**

<b>KIT0067</b>	<b>KIT0068</b>	<b>KIT0070</b>	<b>KIT0071</b>	<b>KIT0072</b>
ON/OFF Driver 1 pc	ON/OFF Driver 1-2 pc	ON/OFF Driver 1-4 pc	ON/OFF Driver 1-10 pc	ON/OFF Driver 10-15 pc

Thin\_Bulbo collection | Linear profiles | 220-240 V | powerLED 18 W



**type** Anod. Al. **8566** **colour** RWB **optics** diffused

Anod. Al. **8567** feat timer

15 h. **ON** 9 h. **OFF**

**electronics**

<b>KIT0068</b>	<b>KIT0070</b>	<b>KIT0071</b>	<b>KIT0072</b>
ON/OFF Driver 1 pc	ON/OFF Driver 1-2 pc	ON/OFF Driver 1-6 pc	ON/OFF Driver 5-10 pc

Thin\_Bulbo collection | Linear profiles | 220-240 V | powerLED 35 W

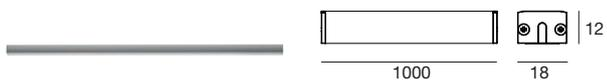

**type** Anod. Al. **8570** **colour** RWB **optics** diffused

Anod. Al. **8571** feat timer

15 h. **ON** 9 h. **OFF**

**electronics**

<b>KIT0069</b>	<b>KIT0071</b>	<b>KIT0072</b>
ON/OFF Driver 1 pc	ON/OFF Driver 1-3 pc	ON/OFF Driver 3-5 pc

Reika\_Bulbo collection | Linear profiles | 220-240 V | powerLED 12 W

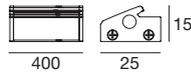

**type**

Anod. Al. **8574**

**colour**

RWB

**optics**

Asym.

Anod. Al. **8575** feat. timer

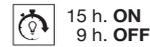

**electronics**



KIT0067	KIT0068	KIT0070	KIT0071	KIT0072
ON/OFF Driver 1 pc	ON/OFF Driver 1-2 pc	ON/OFF Driver 1-4 pc	ON/OFF Driver 1-10 pc	ON/OFF Driver 10-15 pc

Reika\_Bulbo collection | Linear profiles | 220-240 V | powerLED 18 W

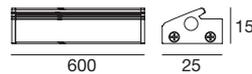

**type**

Anod. Al. **8578**

**colour**

RWB

**optics**

Asym.

Anod. Al. **8579** feat timer



**electronics**



KIT0068	KIT0070	KIT0071	KIT0072
ON/OFF Driver 1 pc	ON/OFF Driver 1-2 pc	ON/OFF Driver 1-6 pc	ON/OFF Driver 5-10 pc

Reika\_Bulbo collection | Linear profiles | 220-240 V | topLED 35 W

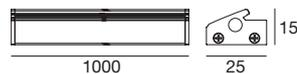

**type**

Anod. Al. **8582**

**colour**

RWB

**optics**

Asym.

Anod. Al. **8583** feat timer



**electronics**



KIT0069	KIT0071	KIT0072
ON/OFF Driver 1 pc	ON/OFF Driver 1-3 pc	ON/OFF Driver 3-5 pc

**Chlorophyll\_Bulbo collection** | Pot light | 220-240 V | 3 x powerLED 7 W

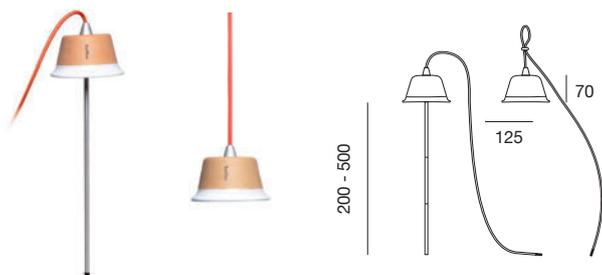

type	colour	optics
Terracotta <b>8010</b>	RWB	120°
Pink <b>8011</b>		
L. Azure <b>8012</b>		

**Vertical\_P1 - Bulbo collection** | Track luminaires | 220-240 V | powerLED 24 W



type	colour	optics
Anod. Al. <b>8584</b>	RWB	diffused
Anod. Bl. <b>8585</b>		
Anod. Al. <b>8586</b>	x2 Vertical_P1 + driver 48 W	
Anod. Bl. <b>8587</b>	x2 Vertical_P1 + driver 48 W	

**Vertical\_P2 - Bulbo collection** | Track luminaires | 220-240 V | powerLED 48 W



type	colour	optics
Anod. Al. <b>8588</b>	RWB	diffused
Anod. Bl. <b>8589</b>		

# Designers

2018

---

designer

**Pio & Tito Toso**

Architects & designers  
Founders of Pio&Tito Toso Studio  
Treviso, Italy  
Products: **Oxygen, Quad, Oblix**



---

designer

**Daide Oppizzi**

Product and lighting designer  
Founder of DCUBE Design  
Espaces Lumière  
Geneve, Switzerland  
Product: **1Night, 2Nights**



---

designer

**Oriano Favaretto**

Product and lighting designer  
Treviso, Italy  
Product: **Eclips**



---

designer

**Marco Piva**

Architect & designer  
Founder of Studio Marco Piva  
Milan, Italy  
Product: **Flurry**



---

designer

**Colin Johnson**

Ceramist & designer  
Founder of Lower Park Ceramics  
Hastings East Sussex, United Kingdom  
Product: **Moonflower**



---

designer

**Anton Petrov & Ilya Korchagin**

Architects & designers  
Founders of ODS LAB Bureau  
Moscow, Russia  
Product: **Dunia**



---

designer

**Lorenzo Antonioni**

Product and lighting designer  
Founder of Bulbo™  
Bologna, Italy  
Products: **Bulbo collection**



---

designer

**Linea Light Group**

R&D department

Product and lighting designers  
Treviso, Italy  
Products: **Diphy, Tablet, La Mariée, Mongolfier, Circle Wave, Lama, Saturn, Kyklos, Reflexio, Square, Entourage, Opti-Line, Mr.Magoo, Xilema, Kimia, Hinomaru, Madame Blanche, Branch, Monarque, Next, Wings, Dynamic**



CODE	PRODUCT	PAGE	CODE	PRODUCT	PAGE
<b>6857</b>	Mr.Magoo_S	209	<b>7465</b>	Branch	256
<b>6858</b>	Mr.Magoo_P	208	<b>7466</b>	Branch	256
<b>6860</b>	Mr.Magoo_P	208	<b>7467</b>	Branch	256
<b>7100</b>	Lama_FL	122	<b>7470</b>	Dunia_P	306
<b>7101</b>	Lama_FL	122	<b>7471</b>	Dunia_S	306
<b>7104</b>	Lama_W	121	<b>7472</b>	Dunia_S	306
<b>7106</b>	Lama_P1	120	<b>7473</b>	Dunia_P	306
<b>7109</b>	Lama_S	121	<b>7520</b>	Dunia_P	306
<b>7110</b>	Lama_S	121	<b>7521</b>	Dunia_S	306
<b>7112</b>	Lama_tab	122	<b>7595</b>	Tablet_S	53
<b>7113</b>	Lama_tab	122	<b>7596</b>	Tablet_S	53
<b>7116</b>	Lama_FL office	122	<b>7600</b>	Tablet_W1	54
<b>7118</b>	Lama_P2	120	<b>7601</b>	Tablet_W1	54
<b>7136</b>	Lama_FL office	122	<b>7602</b>	Tablet_W1	54
<b>7137</b>	Lama_W	121	<b>7604</b>	Tablet_W1	55
<b>7138</b>	Lama_P1	120	<b>7605</b>	Tablet_W1	55
<b>7139</b>	Lama_P2	120	<b>7606</b>	Tablet_W2	53
<b>7411</b>	Wings	282	<b>7607</b>	Tablet_W2	53
<b>7412</b>	Wings	282	<b>7608</b>	Tablet_W1	54
<b>7414</b>	Wings	282	<b>7609</b>	Tablet_W1	54
<b>7415</b>	Wings	282	<b>7610</b>	Tablet_W1	54
<b>7440</b>	Next_S	272	<b>7611</b>	Tablet_W1	55
<b>7441</b>	Next_S	272	<b>7612</b>	Tablet_W1	55
<b>7442</b>	Next_S	272	<b>7613</b>	Tablet_W2	53
<b>7444</b>	Next_P	274	<b>7614</b>	Tablet_W2	53
<b>7445</b>	Next_C	273	<b>7650</b>	Saturn_P	132
<b>7447</b>	Next_W	273	<b>7651</b>	Saturn_S	133
<b>7460</b>	Circle Wave_P	96	<b>7652</b>	Saturn_P	132
<b>7461</b>	Circle Wave_S	96	<b>7653</b>	Saturn_S	133
<b>7462</b>	Circle Wave_P	96	<b>7654</b>	Saturn_W	134
<b>7463</b>	Circle Wave_S	96	<b>7660</b>	Entourage_P2	186

# Code Index

CODE	PRODUCT	PAGE	CODE	PRODUCT	PAGE
<b>7661</b>	Entourage_P2	186	<b>7768</b>	Xilema_W2	224
<b>7662</b>	Entourage_P2	186	<b>7769</b>	Xilema_S	222
<b>7663</b>	Entourage_P1	185	<b>7770</b>	Xilema_S	222
<b>7664</b>	Entourage_P1	185	<b>7771</b>	Xilema_FL	224
<b>7665</b>	Entourage_P1	185	<b>7772</b>	Xilema_FL	224
<b>7666</b>	Entourage_P1	185	<b>7773</b>	Xilema_P	222
<b>7667</b>	Entourage_P1	185	<b>7774</b>	Xilema_P	222
<b>7668</b>	Entourage_P1	185	<b>7775</b>	Xilema_WJ	223
<b>7669</b>	Entourage_P1	185	<b>7776</b>	Xilema_WJ	223
<b>7670</b>	Entourage_P1	185	<b>7777</b>	Xilema_W1	223
<b>7671</b>	Entourage_P1	185	<b>7778</b>	Xilema_W1	223
<b>7676</b>	Entourage_P1	184	<b>7785</b>	Dynamic	314
<b>7677</b>	Entourage_P1	184	<b>7786</b>	Dynamic	314
<b>7678</b>	Entourage_P1	184	<b>7787</b>	Dynamic	314
<b>7694</b>	Entourage_P1	184	<b>7788</b>	Mr.Magoo_P	204
<b>7695</b>	Entourage_P1	184	<b>7789</b>	Mr.Magoo_S	206
<b>7696</b>	Entourage_P1	184	<b>7790</b>	Mr.Magoo_P	208
<b>7697</b>	Entourage_P1	184	<b>7792</b>	Mr.Magoo_S	209
<b>7698</b>	Entourage_P1	184	<b>7799</b>	Mr.Magoo_S	209
<b>7699</b>	Entourage_P1	184	<b>7942</b>	2Nights_W1	108
<b>7740</b>	Kyklos_W	146	<b>7943</b>	2Nights_W2	108
<b>7741</b>	Kyklos_W	146	<b>7944</b>	2Nights_W1	108
<b>7750</b>	Quad_W	68	<b>7945</b>	2Nights_W2	108
<b>7753</b>	Quad_W	68	<b>7963</b>	Flurry	290
<b>7758</b>	Kyklos_W	146	<b>7964</b>	Flurry	290
<b>7759</b>	Kyklos_W	146	<b>7965</b>	Flurry	290
<b>7760</b>	Moonflower	325	<b>7966</b>	Flurry	290
<b>7761</b>	Moonflower	325	<b>7967</b>	Flurry	290
<b>7765</b>	Xilema_W1	223	<b>7968</b>	Flurry	290
<b>7766</b>	Xilema_W1	223	<b>7969</b>	Flurry	290
<b>7767</b>	Xilema_W2	224	<b>7970</b>	Flurry	290



CODE	PRODUCT	PAGE	CODE	PRODUCT	PAGE
<b>7971</b>	Flurry	290	<b>8091</b>	Oxygen_P	38
<b>7975</b>	2Nights_W1	108	<b>8092</b>	Oxygen_P	38
<b>7976</b>	2Nights_W2	108	<b>8093</b>	Oxygen_P	38
<b>7977</b>	2Nights_W1	108	<b>8094</b>	Oxygen_P	38
<b>7978</b>	2Nights_W2	108	<b>8095</b>	Oxygen_P	38
<b>7981</b>	Kyklos_P1	144	<b>8096</b>	Oxygen_P	38
<b>7982</b>	Kyklos_P1	144	<b>8097</b>	Oxygen_FL2	40
<b>7984</b>	Kyklos_P2	145	<b>8098</b>	Oxygen_FL2	40
<b>7985</b>	Kyklos_P2	145	<b>8099</b>	Oxygen_FL2	40
<b>8005</b>	Mr.Magoo_P	204	<b>8100</b>	Oxygen_FL2	40
<b>8006</b>	Mr.Magoo_S	206	<b>8101</b>	Oxygen_FL1	40
<b>8007</b>	Mr.Magoo_P	204	<b>8102</b>	Oxygen_FL1	40
<b>8008</b>	Mr.Magoo_S	206	<b>8103</b>	Oxygen_FL1	40
<b>8009</b>	Mr.Magoo_FL	210	<b>8104</b>	Oxygen_FL1	40
<b>8010</b>	Chlorophyll_Bulbo collection	344	<b>8110</b>	Quad_P9	67
<b>8011</b>	Chlorophyll_Bulbo collection	344	<b>8111</b>	Quad_P9	67
<b>8012</b>	Chlorophyll_Bulbo collection	344	<b>8112</b>	Quad_P12	67
<b>8023</b>	Monarque	264	<b>8113</b>	Quad_P12	67
<b>8025</b>	Monarque	264	<b>8116</b>	Quad_P3	66
<b>8037</b>	Opti-Line	194	<b>8117</b>	Quad_P3	66
<b>8038</b>	Opti-Line	194	<b>8120</b>	Square_SQ	173
<b>8081</b>	Oxygen_S	38	<b>8121</b>	Square_SQ	173
<b>8082</b>	Oxygen_S	38	<b>8122</b>	Square_PQ	172
<b>8083</b>	Oxygen_S	38	<b>8123</b>	Square_PQ	172
<b>8084</b>	Oxygen_S	38	<b>8124</b>	Square_SQ	173
<b>8085</b>	Oxygen_S	39	<b>8125</b>	Square_SQ	173
<b>8086</b>	Oxygen_S	39	<b>8126</b>	Square_PQ	172
<b>8087</b>	Oxygen_S	39	<b>8127</b>	Square_PQ	172
<b>8088</b>	Oxygen_S	39	<b>8128</b>	Square_SB	173
<b>8089</b>	Oxygen_P	38	<b>8129</b>	Square_SB	173
<b>8090</b>	Oxygen_P	38	<b>8135</b>	Mr.Magoo_P	205

# Code Index

CODE	PRODUCT	PAGE	CODE	PRODUCT	PAGE
<b>8136</b>	Mr.Magoo_S	207	<b>8181</b>	Oblix	162
<b>8137</b>	Mr.Magoo_P	205	<b>8182</b>	Oblix	162
<b>8138</b>	Mr.Magoo_S	207	<b>8185</b>	Oxygen_W1	39
<b>8140</b>	Mongolfier_P1	86	<b>8186</b>	Oxygen_W1	39
<b>8141</b>	Mongolfier_P1	86	<b>8187</b>	Oxygen_W1	39
<b>8142</b>	Mongolfier_P1	86	<b>8188</b>	Oxygen_W1	39
<b>8144</b>	Mongolfier_P2	86	<b>8189</b>	Oxygen_W2	40
<b>8145</b>	Mongolfier_P2	86	<b>8190</b>	Oxygen_W2	40
<b>8146</b>	Mongolfier_P2	86	<b>8191</b>	Oxygen_W2	40
<b>8147</b>	Mongolfier_P3	86	<b>8192</b>	Oxygen_W2	40
<b>8148</b>	Mongolfier_P3	86	<b>8450</b>	Tablet_PX	52
<b>8149</b>	Mongolfier_P3	86	<b>8451</b>	Tablet_PX	52
<b>8150</b>	Eclips_W	298	<b>8452</b>	Tablet_FL	55
<b>8151</b>	Eclips_W	298	<b>8453</b>	Tablet_FL	55
<b>8152</b>	Eclips_W	298	<b>8475</b>	Tablet_P1	52
<b>8153</b>	Eclips_W	298	<b>8476</b>	Tablet_P1	52
<b>8155</b>	Eclips_S	298	<b>8478</b>	Tablet_P2	52
<b>8156</b>	Eclips_S	298	<b>8479</b>	Tablet_P2	52
<b>8157</b>	Eclips_S	298	<b>8481</b>	Kyklos_P1	144
<b>8158</b>	Eclips_S	298	<b>8482</b>	Kyklos_P2	145
<b>8165</b>	Diphy_FL	24	<b>8483</b>	Kyklos_P1	144
<b>8166</b>	Diphy_S	24	<b>8484</b>	Kyklos_P2	145
<b>8167</b>	Diphy_S	24	<b>8485</b>	Kyklos_P1	144
<b>8168</b>	Diphy_P3	23	<b>8486</b>	Kyklos_P2	145
<b>8170</b>	Diphy_P1	22	<b>8487</b>	Kyklos_P1	144
<b>8171</b>	Diphy_PC	23	<b>8488</b>	Kyklos_P2	145
<b>8172</b>	Diphy_P1	22	<b>8490</b>	Opti-Line	194
<b>8173</b>	Diphy_P1	22	<b>8491</b>	Opti-Line	194
<b>8174</b>	Diphy_PC	23	<b>8495</b>	Oxygen_W1	39
<b>8175</b>	Madame Blanche	248	<b>8496</b>	Oxygen_W1	39
<b>8178</b>	Madame Blanche	248	<b>8497</b>	Oxygen_W1	39

CODE	PRODUCT	PAGE	CODE	PRODUCT	PAGE
<b>8498</b>	Oxygen_W1	39	<b>8584</b>	Vertical_P1 Bulbo collection	344
<b>8510</b>	Square_PB	172	<b>8585</b>	Vertical_P1 Bulbo collection	344
<b>8511</b>	Square_PB	172	<b>8586</b>	Vertical_P1x2 Bulbo collection	344
<b>8512</b>	Square_SR	174	<b>8587</b>	Vertical_P1x2 Bulbo collection	344
<b>8513</b>	Square_SR	174	<b>8588</b>	Vertical_P2 Bulbo collection	344
<b>8514</b>	Square_PR	174	<b>8589</b>	Vertical_P2 Bulbo collection	344
<b>8515</b>	Square_PR	174	<b>8606</b>	Hinomaru_S	240
<b>8516</b>	Square_SR	174	<b>8607</b>	Hinomaru_S	240
<b>8517</b>	Square_SR	174	<b>8610</b>	Hinomaru_S	240
<b>8518</b>	Square_PR	174	<b>8611</b>	Hinomaru_S	240
<b>8519</b>	Square_PR	174	<b>8614</b>	Hinomaru_P	240
<b>8520</b>	Quad_P7	66	<b>8615</b>	Hinomaru_P	240
<b>8521</b>	Quad_P7	66	<b>8618</b>	Hinomaru_P	240
<b>8530</b>	Reflexio	154	<b>8619</b>	Hinomaru_P	240
<b>8531</b>	Reflexio	154	<b>8625</b>	La Mariée_P	76
<b>8532</b>	Reflexio	154	<b>8626</b>	La Mariée_P	76
<b>8533</b>	Reflexio	154	<b>8627</b>	La Mariée_P	76
<b>8545</b>	Kimia	232	<b>8628</b>	La Mariée_tab	76
<b>8546</b>	Kimia	232	<b>8629</b>	La Mariée_tab	76
<b>8562</b>	Thin_Bulbo collection	342	<b>8630</b>	La Mariée_tab	76
<b>8563</b>	Thin_Bulbo collection	342	<b>8636</b>	1Night	108
<b>8566</b>	Thin_Bulbo collection	342	<b>8637</b>	1Night	108
<b>8567</b>	Thin_Bulbo collection	342	<b>8638</b>	1Night	108
<b>8570</b>	Thin_Bulbo collection	342	<b>8639</b>	1Night	108
<b>8571</b>	Thin_Bulbo collection	342	<b>8640</b>	2Nights_P3	110
<b>8574</b>	Reika_Bulbo collection	343	<b>8641</b>	2Nights_P3	110
<b>8575</b>	Reika_Bulbo collection	343	<b>8642</b>	2Nights_P3	110
<b>8578</b>	Reika_Bulbo collection	343	<b>8643</b>	2Nights_P3	110
<b>8579</b>	Reika_Bulbo collection	343	<b>8644</b>	2Nights_P6	110
<b>8582</b>	Reika_Bulbo collection	343	<b>8645</b>	2Nights_P6	110
<b>8583</b>	Reika_Bulbo collection	343	<b>8646</b>	2Nights_P6	110

# Code Index

CODE	PRODUCT	PAGE	CODE	PRODUCT	PAGE
<b>8647</b>	2Nights_P6	110	<b>KIT0056</b>	2Nights gobo filter	109
<b>99045</b>	DMX Controller	328	<b>KIT0057</b>	2Nights gobo filter	109
<b>99046</b>	DMX Controller	328	<b>KIT0058</b>	2Nights gobo filter	109
<b>99050</b>	DMX Controller	328	<b>KIT0067</b>	Driver	342, 343
<b>99234</b>	DMX Controller	328	<b>KIT0068</b>	Driver	342, 343
<b>99235</b>	DMX Controller	328	<b>KIT0069</b>	Driver	342, 343
<b>KIT0011</b>	Control Unit	326	<b>KIT0070</b>	Driver	342, 343
<b>KIT0019</b>	Driver	326	<b>KIT0071</b>	Driver	342, 343
<b>KIT0020</b>	Driver	327	<b>KIT0072</b>	Driver	342, 343
<b>KIT0021</b>	Driver	327	<b>KIT0079</b>	CASAMBI DALI Dimmer	22, 23, 38, 39, 67, 132, 133, 144, 145, 194, 204, 206, 248, 264, 290
<b>KIT0026</b>	Phase-Cut Dimmer	22, 23, 24, 39, 52, 66, 68, 76, 86, 144, 145, 146, 154, 162, 172, 173, 174, 184, 194, 205, 207, 240	<b>KIT0080</b>	CASAMBI Phase-Cut Dimmer	22, 23, 24, 39, 52, 66, 68, 76, 86, 144, 145, 146, 154, 162, 172, 173, 174, 184, 194, 205, 207, 240
<b>KIT0035</b>	2Nights gobo filter	109	<b>KIT80</b>	Tablet bracket	54, 56
<b>KIT0036</b>	2Nights gobo filter	109	<b>KIT81</b>	Tablet bracket	54, 56
<b>KIT0041</b>	Tablet bracket	54, 56	<b>KIT82</b>	Tablet bracket	54, 56
<b>KIT0042</b>	Tablet bracket	54, 56	<b>KIT83</b>	Tablet bracket	53, 55, 56
<b>KIT0043</b>	Tablet bracket	54, 56	<b>KIT84</b>	Tablet bracket	55, 56
<b>KIT0044</b>	Tablet bracket	53, 55, 56	<b>7650N</b>	Saturn_P	132
<b>KIT0045</b>	Tablet bracket	55, 56	<b>7651N</b>	Saturn_S	133
<b>KIT0046</b>	Tablet bracket	53, 56	<b>7652N</b>	Saturn_P	132
<b>KIT0047</b>	Tablet bracket	53, 56	<b>7653N</b>	Saturn_S	133
<b>KIT0048</b>	Fixing bracket	325	<b>7788N</b>	Mr.Magoo_P	204
<b>KIT0049</b>	Cable	325	<b>7789N</b>	Mr.Magoo_S	206
<b>KIT0050</b>	Cable	325	<b>8005N</b>	Mr.Magoo_P	204
<b>KIT0051</b>	Splitter	326, 327	<b>8006N</b>	Mr.Magoo_S	206
<b>KIT0052</b>	Cable	326, 327	<b>8007N</b>	Mr.Magoo_P	204
<b>KIT0053</b>	Cable	326	<b>8008N</b>	Mr.Magoo_S	206
<b>KIT0054</b>	Cable	326			
<b>KIT0055</b>	2Nights gobo filter	109			

# Symbols

	Indoor installation		Driver not included
	Outdoor installation		Installation hole
	Wall mounting		Double emission luminaire
	Ground mounting		Device suitable to be mounted on furniture
	Ceiling mounting		Device suitable to be mounted on normally flammable surfaces (EN 60598)
	Ceiling or wall mounting		DMX 512
	Recessed mounting - ceiling		DALI / Push DIM (except for codes 8185, 8186, 8187, 8188 - dimmable only in DALI)
	Recessed mounting - wall		Phase-Cut
	Protection class (IEC 60529) against foreign bodies and water		Push DIM
	Directional light beam		Warm Tune
	Tilting light beam	c.c.	Constant Current
	Power supply cable included	c.v.	Constant Voltage
	Class I - IEC protection class		Featuring timer
	Class II - IEC protection class		Dimmer inside the body lamp
	Class III - IEC protection class		Dimmer outside the body lamp
	Driver included		

IT — Tutti gli articoli sono in classe energetica A++. I lumen indicati si riferiscono all'emissione della sorgente. Gli schemi di collegamento per gli articoli dell'elettronica sono disponibili all'interno della documentazione tecnica.

DE — Alle Artikel gehören zur Energieeffizienzklasse A++. Der angegebene Wert in Lumen bezieht sich auf die Abstrahlung der Lichtquelle. Die Anschlusspläne der elektronischen Artikel sind in der technischen Dokumentation enthalten.

EN — All articles belong to energy class A++. The lumens indicated refer to the light source emission. The connection diagrams for electronics articles are included in the technical documentation.

ES — Todos los artículos son de clase energética A++. Los lúmenes indicados se refieren a la emisión de la fuente luminosa. Los esquemas de conexión para los artículos de la electrónica están disponibles dentro de la documentación técnica.

FR — Tous les articles sont en classe énergétique A++. Les lumens indiqués se réfèrent à l'émission de la source lumineuse. Les schémas de branchement pour les articles électroniques sont disponibles à l'intérieur de la documentation technique.

PY — Все артикулы имеют класс энергопотребления A++. Указанное значение в люменах относится к излучению источника света. Схемы соединений для электронных изделий приведены в технической документации.

# How To

Famiglia  
Family  
Familie  
Familie  
Familia  
Семья

Informazioni prodotto  
Product information  
Informations sur le produit  
Produktinformationen  
Informaciones sobre el producto  
Информация об изделии

Tabella composizione  
Composition table  
Tableau de composition  
Tabelle Zusammensetzung  
Tabla de composición  
Таблица композиции

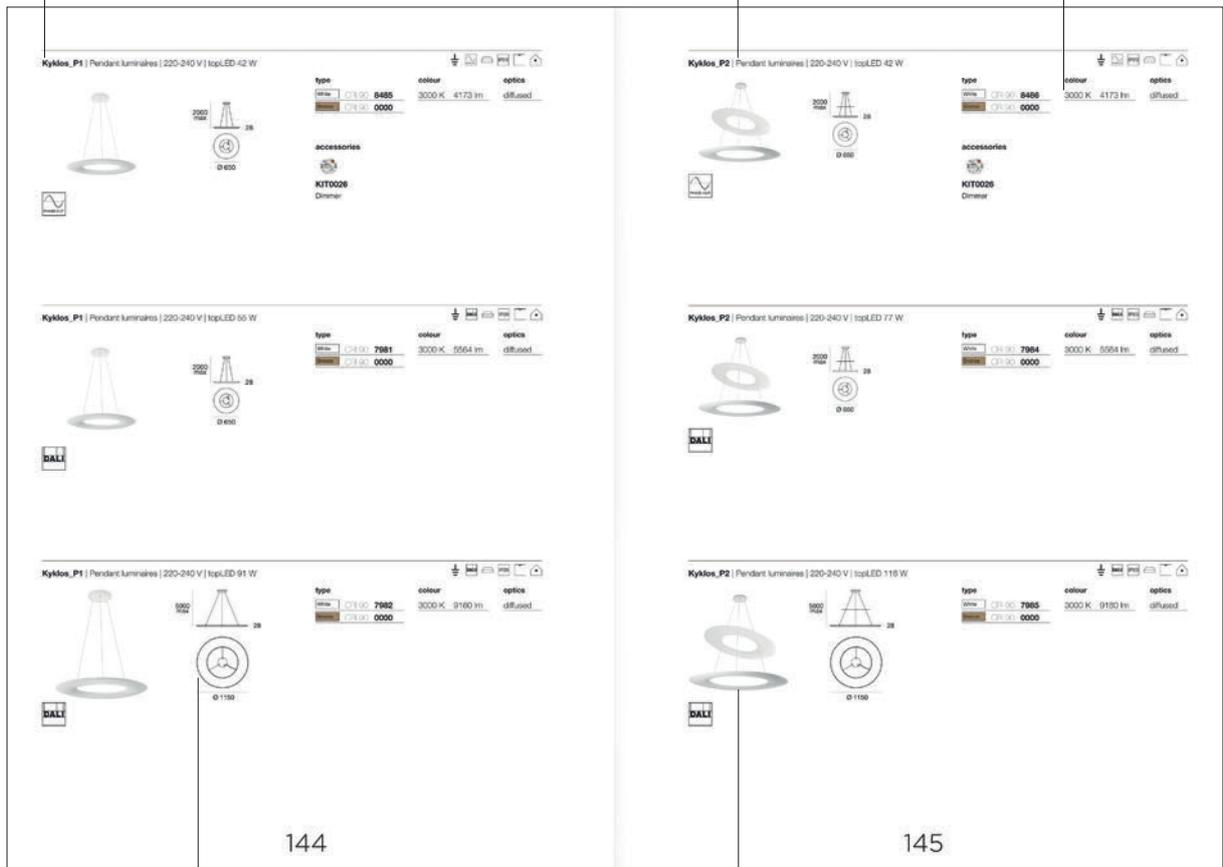

144

145

Disegno tecnico quotato  
Dimensioned technical drawing  
Cotation du dessin technique  
Bemaßte technische Zeichnung  
Dibujo técnico acotado  
Технический чертёж с размерами

Dettaglio prodotto  
Product detail  
Détail du produit  
Produktdetails  
Detalle del producto  
Характеристика изделия

# Finishes



White\_RAL 9003 embossed



Grey\_RAL 9006 embossed



Black\_RAL 9005 embossed



Yellow



Azure



Light Azure\_Glossy



Pink\_Glossy

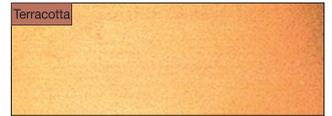

Raw Terracotta



Transparent\_Glass



Copper\_Glass



Smoked\_Glass



Anodized aluminium



Anodized black aluminium



Polished aluminium



Black nickel\_Finish



Gold\_Finish



Rose Gold\_Finish



Champagne\_Finish



Brushed Bronze\_Finish



Brushed Rose\_Finish



Brushed Black\_Finish

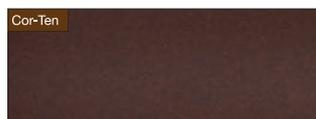

Cor-Ten\_Finish

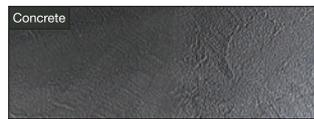

Concrete\_Finish



Gypsum\_Finish



Prismatic



Granular

# Addresses

## Linea Light S.r.l. Italy

via della Fornace, 59 z.i.  
31023 Castelminio di Resana (TV) - Italy  
Phone: +39 0423 78 68  
Fax: +39 0423 78 69 00  
info@linealight.com

## Linea Light Roma

Via Stendhal, 22  
00144 Roma - Italy  
Phone: +39 06 5935106  
info@linealightroma.com

## LightVillage Milano

Exhibition Area Only  
via Morimondo, 26 int. 17G  
20143 Milano - Italy  
Phone: +39 02 36750915  
Fax: +39 02 36750915  
milano@lightvillage.it

## Linea Light France

Z.A. Heiden Est, 12 rue des Pays-Bas  
68310 Wittelsheim - France  
Phone: +33 389 75 52 23  
Fax: +33 389 75 59 07  
info@linealight.fr

## Linea Light Deutschland GmbH

Aktienstraße 214  
45473 Mülheim a.d. Ruhr - Germany  
Phone: +49 208 299979-0  
Fax: +49 208 299979-10  
service@linealight.de

## Linea Light Polska Sp. z o.o.

ul. Wiosenna, 47  
41253 Czeladz - Poland  
Phone: +48 32 760 98 71  
Fax: +48 32 760 98 76  
biuro@linealight.com.pl

## Linea Light USA - Inter Lux

3741 Commerce Drive  
Suites 306-308  
Baltimore, MD 21227 - USA  
Phone: +1 410 381 1497  
Fax: +1 410 381 1589  
answers@inter-lux.com

## Linea Light UK Ltd

Suite 109 - Business Design Centre  
52 Upper Street - Islington N10QH  
London - UK  
Phone: +44 0203 6371983  
info@linealight-uk.com

## Linea Light Russia

Luzhnetskaya nab., 2/4, str. 3, of. 304  
119270 Moscow - Russian Federation  
Phone: +7 495 639 99 41  
info@linealight.ru

## Linea Light GCC

Middle East & Gulf Countries  
Jumeirah Lake Towers  
JBC2 - 35th Floor Office 02 - Dubai - UAE  
P.O. Box 125902  
Phone: +971 4 4218275  
Fax: +971 4 4218274  
info@linealight.ae

## Linea Light Asia - Pacific Ltd

YuXiang Industrial Area  
528478 HengLan Town, ZhongShan City,  
GuangDong Province, China  
Phone: +86 760 87618355  
Fax: +86 760 87553990  
info@linealight.cn

## Linea Light Singapore

Operative office  
21 Kaki Bukit Place, 5th Floor  
416199 Singapore  
Registered office  
180 Cecil Street, #10-02  
Bangkok Bank Building  
069546 - Singapore  
Phone: +65 6908 5758  
info@tfoasia.com



linealight.com



Art direction:  
Linea Light Group - Marketing Dept.

Concept:  
SR Communication Solutions

Photographers:  
Giorgio Gori - Oak Seed Studio  
Studio Pointer [A.D. S. Bortoletto\_Styling V. Brunetta]  
Bulbo™

Copywriter:  
Andrea Pietro Calatroni  
Linea Light Group - Marketing Dept.

Press:  
Tipografia Asolana

Thanks to:  
INFINITI - OMP CHAIRS  
Arredo3 Cucine  
H-Farm  
Centro Commerciale Ca' Grande

Printed in Italy  
June 2018

<sup>IT</sup> — I disegni, le quote, i materiali ed i colori del presente catalogo si intendono a titolo indicativo. Nell'interesse della clientela, l'Azienda si riserva il diritto di modificare i modelli in ogni momento senza l'obbligo di preavviso.

<sup>DE</sup> — Die Zeichnungen, die Maße, die Materialien und die Farben im vorliegenden Katalog sind reine Anhaltswerte. Im Interesse der Kundschaft behält sich das Unternehmen das Recht vor, die Modelle jederzeit ohne Vorankündigung zu ändern.

<sup>EN</sup> — The drawings, dimensions, materials and colours contained in this catalogue are merely indicative. In the customers' interest, the Company reserves the right to modify the models at any time without notice.

<sup>ES</sup> — Los diseños, las medidas, los materiales y los colores de este catálogo tienen valor puramente indicativo. En interés de la clientela, la Empresa se reserva el derecho de modificar los modelos en cualquier momento sin obligación de aviso previo.

<sup>FR</sup> — Les dessins, les cotes, les matériaux et les couleurs du présent catalogue sont purement à titre indicatif. Dans l'intérêt de la clientèle, l'Entreprise se réserve le droit de modifier à tout moment les modèles sans obligation de préavis.

<sup>PY</sup> — Чертежи, размеры, материалы и цвета, приведенные в настоящем каталоге, носят ориентировочный характер. В интересах клиентов Компания оставляет за собой право вносить изменения в модели в любой момент без обязанности предварительного предупреждения.





**Your Light** | Future Proof